



Profibus DP Repeater

HDP-200



Introduction

Thank you for choosing our Profibus DP Repeater HDP-200. To ensure the proper and efficient way of usage, it's very important to read all this manual sequentially to understand how to operate and install the HDP-200, before putting it into operation.

About this Manual

1. This manual should be delivered to the end user of the Profibus DP Repeater HDP-200;
2. The contents of this manual may be changed without notice;
3. All rights reserved. No part of this manual may be reproduced in any kind without DLG's permission;
4. All the specifications in this manual are limited to the standard products models and do not cover special products or made by order;
5. All precautions were taken on preparing this manual, in order to guarantee the quality of this information.

CAUTION!

The instrument described in this technical user manual is a device suitable for application in a specialized technical area. DLG's products are submitted to a strict quality control process. However, industrial control electronic equipment can cause damage to machinery or processes controlled by them in the event of any failure or improper uses and may even endanger human lives. The user is responsible for setting and selecting values of the parameters of the instrument. The manufacturer warns of the risks of incidents with injuries to both people and goods, resulting from the incorrect use of the instrument.

Contents

PRESENTATION	5
TYPICAL APPLICATIONS	6
TECHNICAL SPECIFICATIONS.....	7
General Characteristics	7
DIMENSIONS	8
FRONTAL.....	9
OPERATION.....	10
ELECTRIC INSTALLATION	11
SEGMENTS INSTALLATION	12
Power supply	13
Profibus DP Communication.....	13
MECHANICAL INSTALLATION	14
RECOMMENDATIONS.....	15
WARRANTY	16

Presentation

The Profibus DP Repeater HDP-200 permits expansion and subsequent regeneration of the RS-485 communication signals, amplifying data signals and coupling Profibus DP segments. Terminating circuits has been incorporated in both channels, eliminating the use of active terminators and can be mounted on standard 35mm DIN rails.



Below we highlight some features:

- Cascading up to 16 repeaters
- Power supply for 24V
- 2 channels galvanic isolated
- Amplification of data signals
- Anti-glitch filter for transmission signals
- 32 Devices per segment
- Maximum cable length: 1200m at 9.6kbps
- AutoBaudrate supports 9.6kbps to 12Mbps
- Compatible with Profibus DP and FMS protocols
- No address necessary
- Cable: type A according to EN50170
- 1 Power supply indicator led
- 2 Bus status leds
- 1 Profibus DP frontal DB9 Connector
- Screw connector for 2 A/B signals and shield protector.
- Compact and low profile.

Typical Applications

The Profibus DP Repeater HDP-200 should be used in the following situations:

- If More than 32 connected nodes in the bus.
- If the segments can't be connected in any manner at a given shield or common ground.
- If the maximum cable length estimated by the baud rate of the configuration, has been reached by the RS-485 standard.

In the Figure 1, a typical application of the HDP-200 is illustrated.

Due to the characteristic impedance of RS-485 transceivers to be around $12K\Omega$, care must be taken to use a maximum of 32 nodes per network segment, to not compromising the communication channel. Therefore, to increase the scale of the network repeaters should be used.

In some circumstances, ground loops are present in the bus segments and must be canceled, thus as the HDP-200 repeater has 2 isolated communication channels, it is possible to solve many problems of the physical layer.

When the cable length limit by the communication speed is reached, the HDP-200 repeater assists in the configuration of fast and big networks, with amplifying and regenerating the data signal.

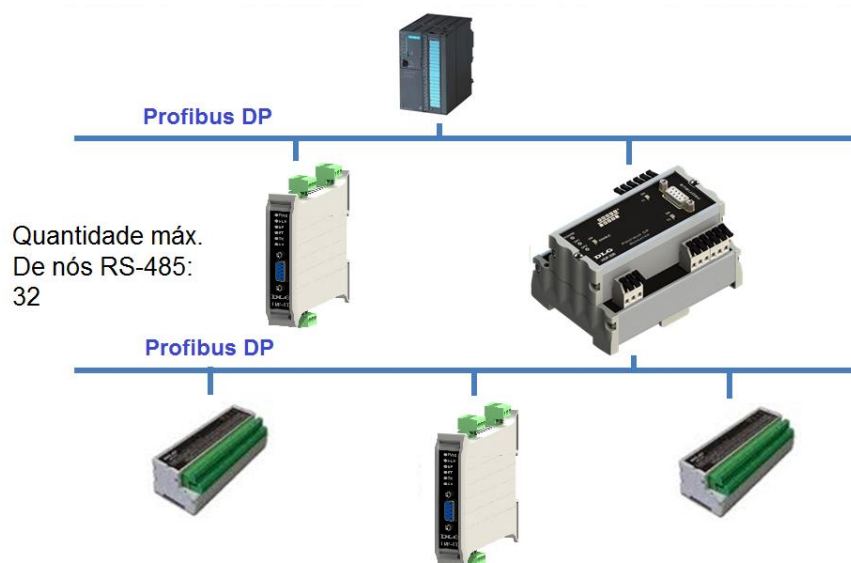

Figure 1 - HDP-200 Application.

Technical specifications

General Characteristics

Tipo	Observações
Communication	RS-485 PROFIBUS: (DP, DP-V1, DP-V2, PROFIdrive, MPI, etc.) and FMS Protocols
Isolation	Galvanic max. 450Vp
Baud Rates	9.6k, 19.2k, 45.45k, 93.75k, 187.5k, 500k,1.5M,3M ,6M e 12M
Profibus Cable:	Type A acc. EN50171
Operation Temperature	0 °C a 60 °C
Storage Temperature	-40 °C a 70 °C
Thermal Stability	±0,005% / °C do span @ 25°C.
Relative humidity	Up tp 90%
IP Protection	IP-20 (DIN EN 60529 VDE 0470)
Power Supply	20.4 a 28.8 Vcc
Power Consumption	max. 200mA
Case Material	ABS
Placement	DIN35 rail (DIN EN 60715 TH35)
Electric connection	Maximum Cable 2.5mm ² with screw connectors.
Aprox. Weight	0,2Kg
Dimensions	75,4 x 104 x 58,5 mm. (Height x Width x Depth).

Dimensions

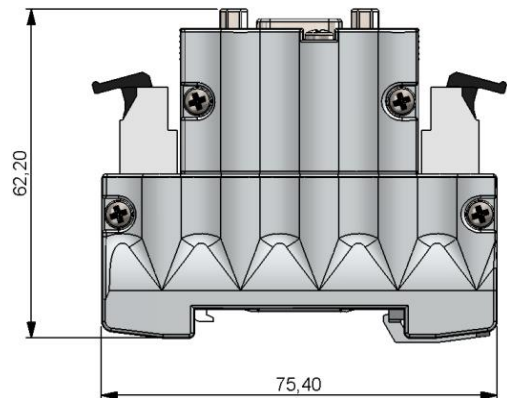
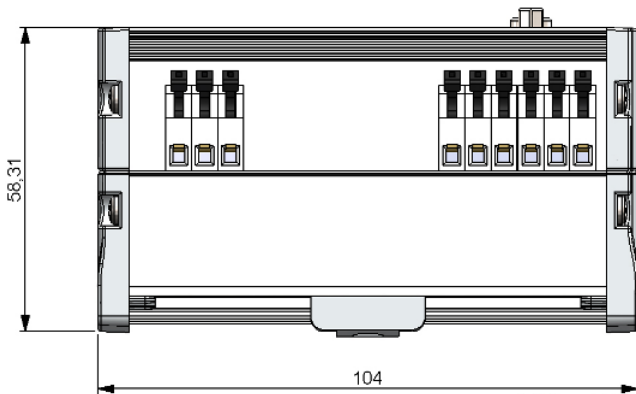
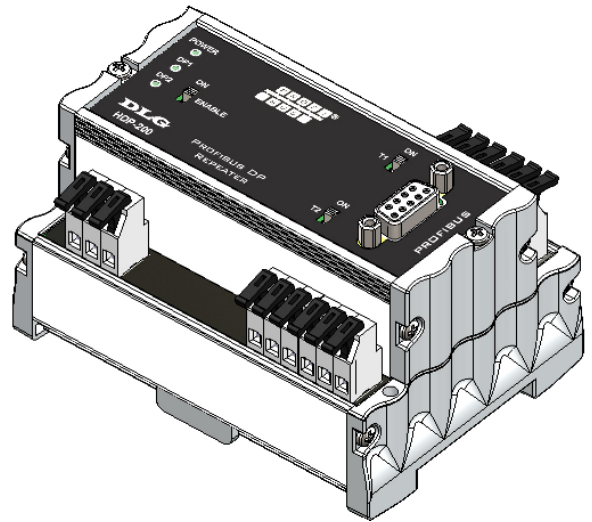
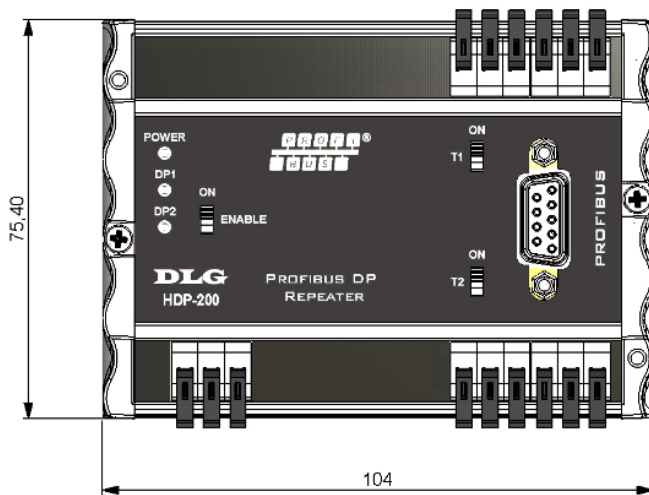

Figure 2 – Dimensions for assembly (in millimeters)

Frontal

LED	Cor	Descrição
PWR	Green	(Power) Indicates that the power supply is on. LED continuously on shows the correct state of the power supply.
DP1/DP2	Green	When the Profibus DP transactions are successful, the DP1 and DP2 leds will be on in the two way of data. When just one of the leds blinks, it indicates that the master is trying to establish communication, but no answer of any slave. When a master is not connected or not operant and leds DP1 or DP2 blinks, it should be an impropriate installation.

Chave	Pos.	Descrição
Enable	ON	The two Profibus DP channels will be coupled when the switch is "ON"
Enable	OFF	The two Profibus DP channels will not be coupled when the switch is "OFF" and remains with high impedance between them.
T1	ON	Just the bus Channel 0 will be terminated with the resistors 390-220-390. The derivations in the connectors A0/B0 are not connected.
T1	OFF	The derivations in the connectors A0/B0 are connected without terminators.
T2	ON	Just the bus Channel 1 will be terminated with the resistors 390-220-390. The derivations in the connectors A1/B1 are not connected.
T2	OFF	The derivations in the connectors A1/B1 are connected without terminators.



Operation

The Profibus DP Repeater HDP-200 has been created in a manner that it can be totally transparent between the 2 segments of the Profibus that he is inserted. With 2 RS-485 isolated communication channels and active terminators integrated, it can decouple the bus segments through the “ENABLE” switch.

Due to the low signal delay between channels that is about 1Tbit, it is possible to use the same master for up to 16 Profibus repeaters cascaded with a limit of up to 32 nodes per segment, respecting the maximum distance of 1200m to 9600bps.

The Profibus DP Repeater HDP-200 has autobaudrate and automatic flow control, which is compatible with 9600bps to 12Mbps, with no further configurations needed. Both Profibus DP and MPI or any other kinds of FMS protocol are supported.

The HDP-200 incorporate an anti-glitch filter which attenuates the presence of noise on the bus and minimize the effects of noise present in both channels.

Electric Installation

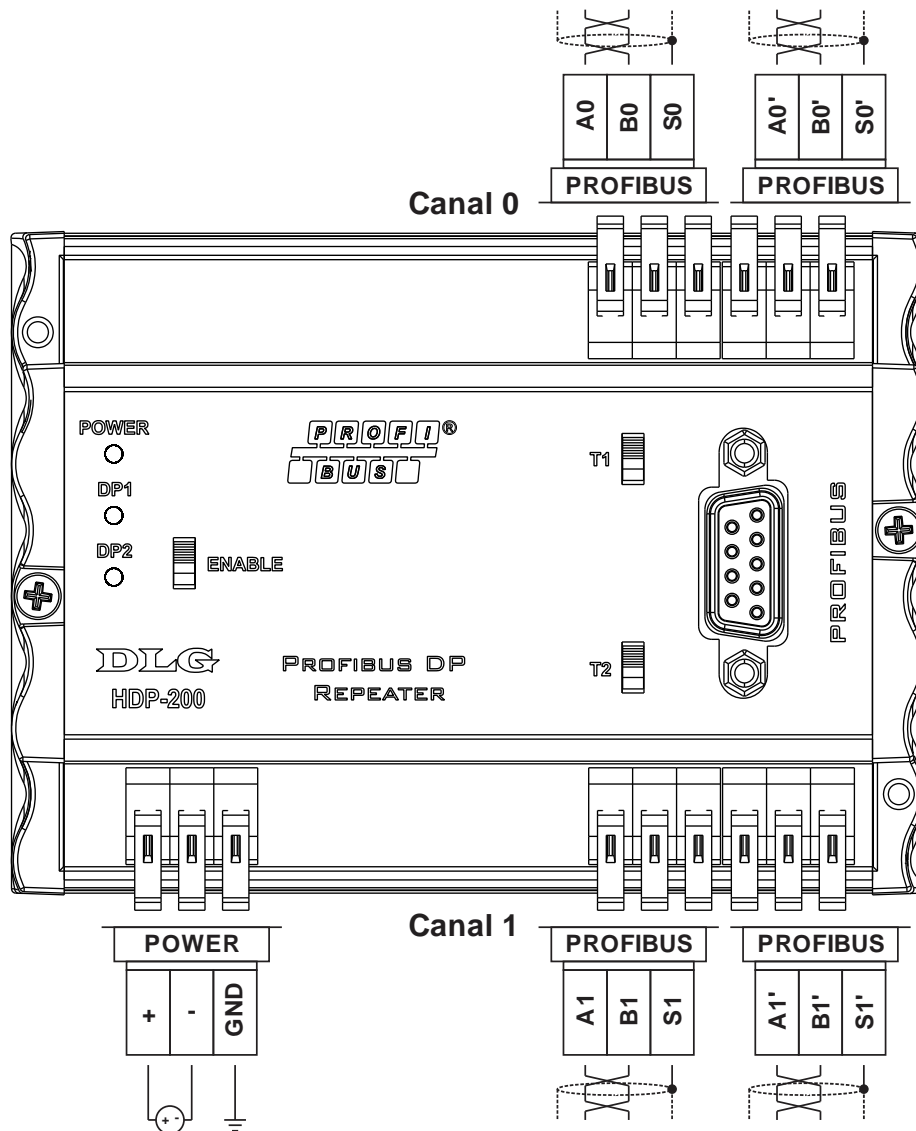

Figure 3 – HDP-200 Electric connections.

Attention: All the cables shall be crimped with proper terminals to 1.5mm² when not specified. For the interconnection of communication signals, we recommend using standard Profibus cables with "shield" and grounding should be done in SH connector and every other ground points existing till the end of the bus.

Segments Installation

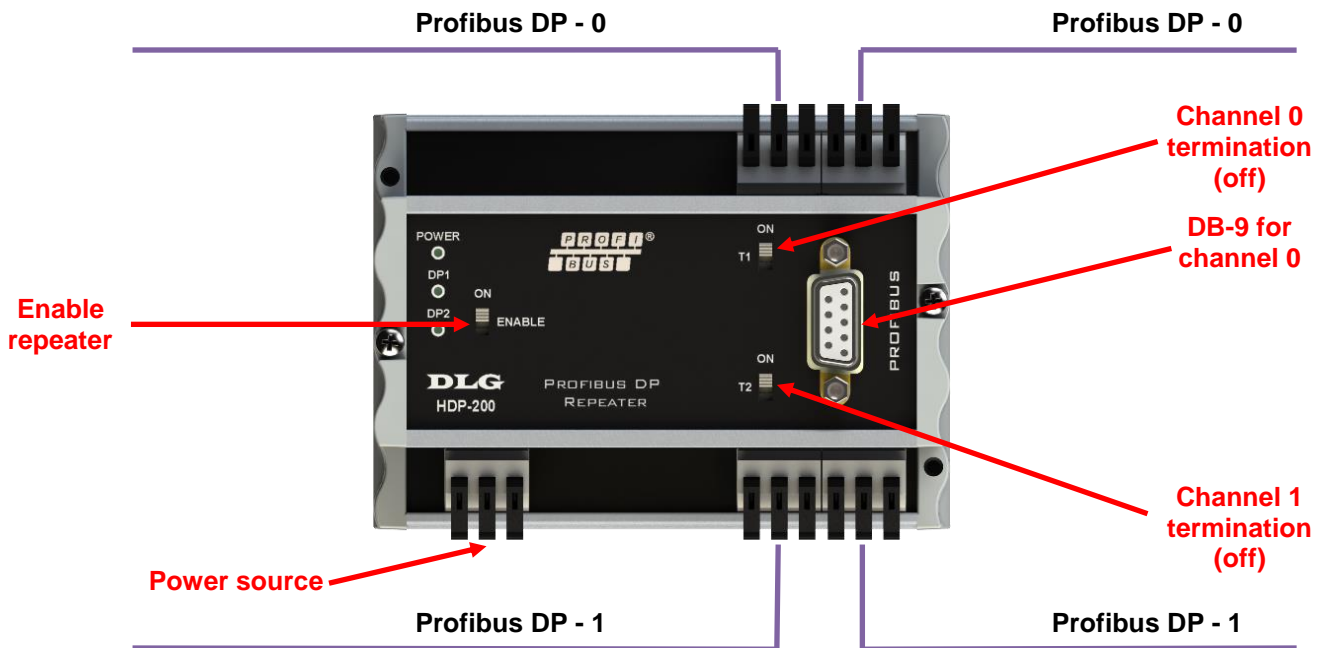

Figure 4 – Installation without termination

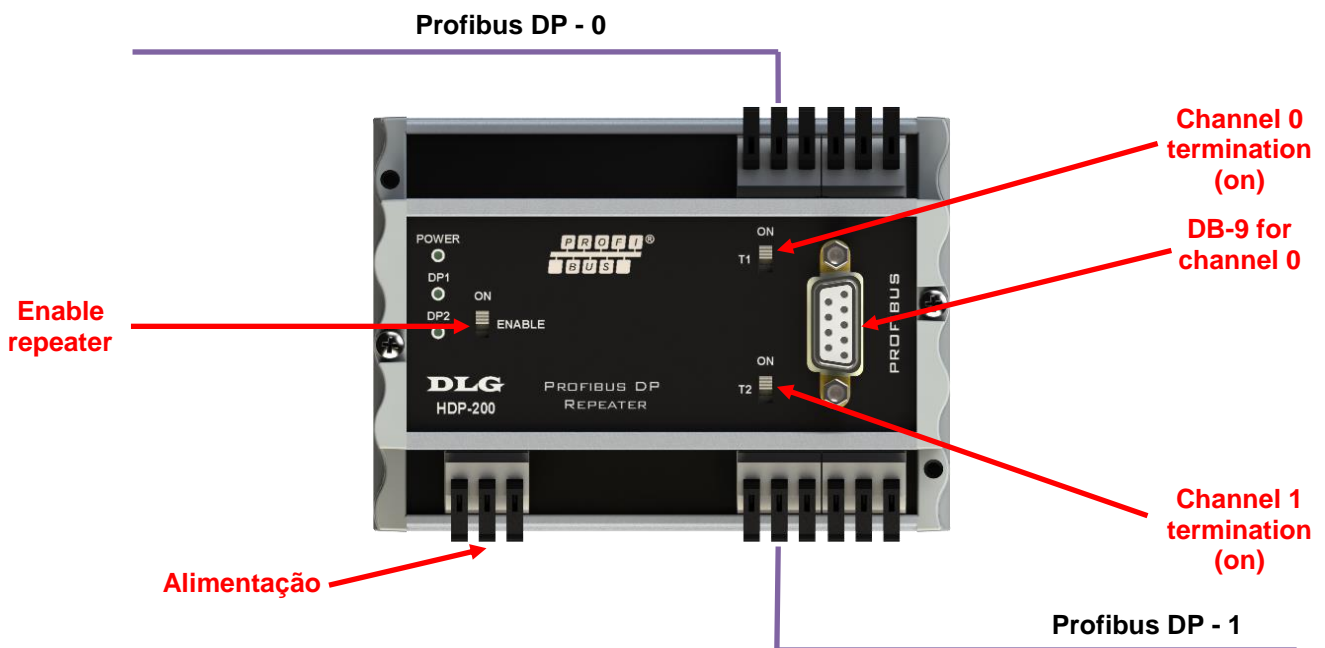
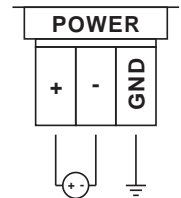

Figure 5 – Installation with termination

Power supply

The HDP-200 shall be energized through the + and - terminals with a voltage of 24 V with a range of 20.4 to 28.8 Vdc. The GND terminal is used for grounding to the panel and the recommended cables are 1.5mm² and 2.5mm² to ground. The wiring diagram is described aside.



Profibus DP Communication

The HDP-200 has 2 serial communication channels using the Profibus DP protocol with a RS-485 physical layer. The channels can be accessed by upper and lower terminal equipment: positive (B), negative (A) and shield (S), as illustrated in Figure 3.

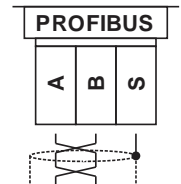

The Channel 0 can also be accessed with conventional DB9 connectors to the Profibus DP protocol through the frontal.

The DB9 connector and the terminals of the channel 0 are connected internally and both can be used simultaneously. For example, the HDP-200 can be connected to the profibus master by the screw connectors and a protocol analyzer can be used to the DB9 connector, without causing any disturbing to the correct operational.

Mechanical Installation

First place the HDP-200 in the top DIN rail.



Push the HDP-200 down until you hear a "click". Now the HDP-200 is placed in the rail.

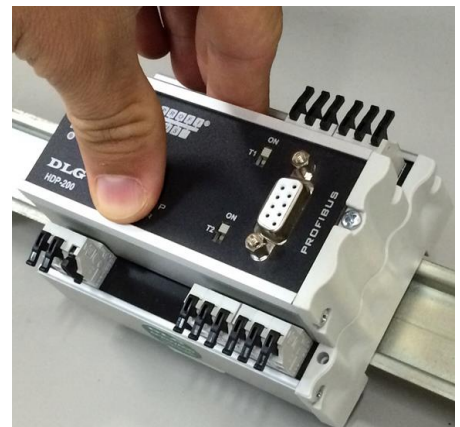

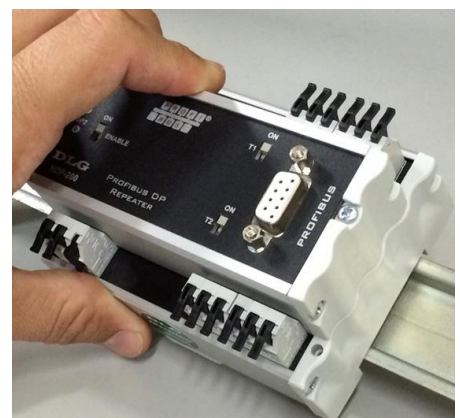

To release the HDP-200 from the rail, just push it to the bottom and next to up and pull the top out.



Recommendations

It's high recommended to the user that just use proper tools and equipment for the installation and maintenance of the HDP-200.

<p>For the screw connectors it is essential to use screwdriver for 1/8" with a maximum diameter of 3mm. It is the ideal format and will not damage the connector's hole of the HDP-200.</p>	 <p>No recommended switch</p>	 <p>Recommended switch</p>
<p>We recommend to crimp all the wires that will be connected to the HDP-200 with needle terminals for cables of 0.5 to 1.5 mm² like the figure aside.</p>	<p>Needle terminals</p> 	

Warranty

The manufacturer assures to the equipment owners, identified by the purchase invoice, warranty of 1 (one) year as follows:

1. The warranty period begins on the date of the invoice issue.
2. Within the warranty period, the labor and parts used for repairing damage occurred in normal use are free.
3. For repairs, send the equipment along with the shipping invoices to our factory in Sertãozinho, São Paulo, Brazil. DLG's address is available at the end of this manual.
4. The owner is responsible for transportation costs and risks.
5. Warranty will be automatically suspended if changes were made to the equipment by personnel not authorized by DLG, defects caused by mechanical shock, exposure to conditions unfit for use or tampering with the product.
6. DLG disclaims any charge relating to unauthorized repairs or replacements due to failures caused by agents external to the equipment, the improper use of them and as a result of unforeseeable circumstances or major forces.
7. DLG ensures full operation of the equipment described in this manual and all existing operations.

Notes



<p>DLG Automação Industrial Ltda. Rua José Batista Soares, 53 Distrito Industrial – 14176-119 Sertãozinho – São Paulo – Brasil Fone: +55 (16) 3513-7400 www.dlg.com.br</p>	<p>MAN-EN-DE-HDP200- 01.00_16</p>	<p>PROFIBUS DP REPEATER HDP-200</p> <p>A DLG reserva-se no direito de alterar o conteúdo deste manual sem prévio aviso, a fim de mantê-lo atualizando com eventuais desenvolvimentos do produto.</p>
---	---------------------------------------	--