



Modbus

MODBUS UNIVERSAL INDICATOR IM-111



Introduction

Thank you for choosing our MODBUS UNIVERSAL INDICATOR IM-111. To ensure its proper and efficient usage, it's important to read this user manual thoroughly to understand how to operate the IM-111, before operating it.

About this Manual

1. This manual should be delivered to the end user of the IM-111;
2. The contents of this manual are subject to change without notice;
3. All rights reserved. No part of this manual may be reproduced in any form without the written consent from DLG;
4. The specifications contained herein are limited to standard models and do not cover customized versions;
5. All precautions were taken on preparing this manual, in order to guarantee the quality of its information

CAUTION!

The instrument described in this technical user manual is a device suitable for application in a specialized technical area. DLG supplied products are submitted to a strict quality control process. However, industrial control electronic equipment may cause damage to machinery or processes controlled by them in the event of any failure or improper operations and may even endanger human lives. The user is responsible for setting and selecting values of the parameters of the instrument. The manufacturer warns of the risk of incidents with injuries to both people and goods, resulting from the incorrect use of the instrument.

Contents

1 - PRESENTATION	6
2 - FEATURES	7
3 - TYPICAL APPLICATIONS	8
4 - TECHNICAL SPECIFICATIONS	9
4.1 - ELECTRICAL CHARACTERISTICS	9
4.2 - GENERAL CHARACTERISTICS	10
5 - HOW TO SPECIFY	10
6 - DIMENSIONS	11
7 - FUNCTIONALITY	12
7.1 - Frontal DISPLAY	12
7.2 - KEYPAD FUNCTIONALITY	13
7.2.1 - Menu navigation.....	13
7.2.2 - Submenu navigation	14
7.2.3 - Leaving configuration mode	14
7.2.4 - Locking and unlocking the frontal keypad	14
7.2.5 - Ambient temperature indication.....	14
7.2.6 - Linearization curve input indication	15
8 - CONFIGURATION	16
8.1 - SUBMENU DETAILS	16
8.1.1 - Input menu	16
8.1.2 - Alarm menu.....	18
8.1.2.1 - Alarm operation.....	19
8.1.2.2 - Alarm timing	20
8.1.3 - Output menu	21
8.1.4 - Linearization menu.....	22
8.1.5 - Modbus communications menu.....	23
9 - MODBUS TABLE	24
9.1 - READ-ONLY BIT MASKS	26
9.2 - READ-write bit masks	27
10 -ELECTRICAL INSTALLATION	29
10.1 - REAR CONNECTORS	29
10.2 - INPUT SIGNAL CONNECTION.....	30
10.3 - OTHER CONNECTIONS.....	33
11 -MECHANICAL INSTALLATION	37

11.1 -	REQUIRED PANEL SPACE.....	37
12 -	RECOMMENDATIONS.....	38
12.1 -	RS-485 CABLING.....	39
12.1.1 -	Cable length	39
13 -	WARRANTY	40

1 - PRESENTATION

The IM-111 (Universal Modbus Indicator) is an indicator capable of acquiring signals as electric voltages, currents, frequency, temperature sensors like Pt100, among others, and also capable of retransmitting them in standard 0/4 – 20 mA or 0/2 – 10 Vdc. The indicator is equipped with two solid state relays that can be linked to alarms.

The process variable is shown in the frontal of the IM-111 through the display for easier visualization and configuration.

The IM-111 is equipped with serial communications and can be connected to a Modbus/RTU network, suitable for SCADA systems. It also comes with DLGTools software, used to configure all DLG Automation via ModBus network, free of charge.

The indicator is fully configurable via the frontal keypad or by the freely available DLG Tools software, without the need for jumpers.



2 - FEATURES

Input types:

- Thermocouples types J, K, T, R, S, E, N and B
- Pt100 thermoresistance
- 0-20 mA, 4-20 mA currents
- 0-100 mV, 0-5 V, 0-10V voltages
- Frequency
- Logic level
- Digital

Other:

- Two SPDT relay outputs.
- PV retransmission in 0/4-20 mA or 0/2-10 Vdc.
- Output state indication via the frontal display.
- RS-485 serial communications, Modbus/RTU protocol.
- Low, high, differential and inverted differential alarms.
- Multifunction keypad.
- Cold junction compensation for thermocouple sensors.
- Filter against power supply electromagnetic noise.
- Communications rate and address configurable by the user.
- Universal input voltage.
- Detachable rear connection.

3 - TYPICAL APPLICATIONS

- Temperature indication
- Motor rotation indication
- Level indication
- Pressure indication
- Variable linearization
- Flow measurement

4 - TECHNICAL SPECIFICATIONS

4.1 - ELECTRICAL CHARACTERISTICS

Type	Parameter	Mín	Max	Comments	Unit
Input signal	Current	0/4	20		mA
	Voltage	0	0,1*/5/10	*0,1 V = 100mV (0 - 100mV)	Vdc
	Thermocouple	–	–	J, K, T, R, S, E, N, B	°C
	Pt100	–200	850	Three wire	°C
	Frequency	0.4	30000	0.5 – 60 Vdc sensibility**	Hz
	Logic level	0	10	0 – 3 Vdc: logic level 0 5 – 10 Vdc: logic level 1	Vdc
	Digital	12	24	External power supply required	Vdc
Input impedance	Current	50			Ω
	Voltage	405			KΩ
	Thermocouple	280			KΩ
	Pt100	50			KΩ
	Frequency	100			KΩ
Accuracy	Current	±0.1% span			
	Voltage	±0.1% span			
	Thermocouple	J, K, T and N		±(0.1% span + 1°C)	
		E, R, S and B		±(0.1% span + 3°C)	
	Pt100	±0.1% span			
	Frequency	0.1 Hz for 0.4 < f < 1000 Hz 1 Hz for 1000 < f < 30000 Hz			
Cold junction compensation	0.5			°C	
Display	Five 7-segment displays with decimal point				
Scale	–9999 a 30000 in engineering units for voltage, current and frequency				
Sampling time (internal)	10 samples per second				
Refresh rate for frequency input	For 0.4 < f < 999 Hz		480	ms	
	For f > 1000 Hz		1000	ms	
PV retransmission	0/4 – 20 mA output with 750 Ω max load or 0 – 10 Vdc output with 30 mA max load. Accuracy: ±0.1% span.				
Alarms	Two SPDT relay outputs, 3 ^a /220 Vac each AL2 SPDT max. 3A/220Vac				
Auxiliary power supply	24Vdc 50mA				

****NOTE:** the table below specifies the minimum voltage level (square wave amplitude) required for the indicator to detect the frequency signal properly:

Input signal (Hz)	Minimum square wave voltage amplitude (Vdc)
1000	1.23
2000	1.24
3000	1.25
4000	1.27
5000	1.34
10000	1.80
15000	2.40
20000	3.00
25000	3.70
27700	4.00
30000	4.50

WARNING: When using frequency signals, it is extremely important to consider proper grounding so noise effects are minimized.

4.2 - GENERAL CHARACTERISTICS

Type	Specification
Operating temperature	0 °C - 50 °C
IP protection	IP-20 rear, IP-63 frontal.
Input voltage	IM-111/AC: 90 ~ 240 Vac, 60Hz or 100 ~ 130 Vdc
	IM-111/DC: 18 ~ 30 Vdc
Power consumption	5 VA
Construction	ABS plastic frontal, for panel mounting
Electrical connections	"Plug-in" type removable connectors
Approx. weight	0.2 kg
Dimensions	50 x 98 x 152.6 mm (height x width, depth).
Panel space required	42 x 90 mm

5 - HOW TO SPECIFY

IM-__11 / ____	
Finishing / Enclosure	
1	Standalone universal indicator (IM-111)
6	Universal indicator installed inside a IP-65 box (IM-611)
Power	
AC	90 ~ 260 Vac
DC	18 ~ 30 Vdc

6 - DIMENSIONS

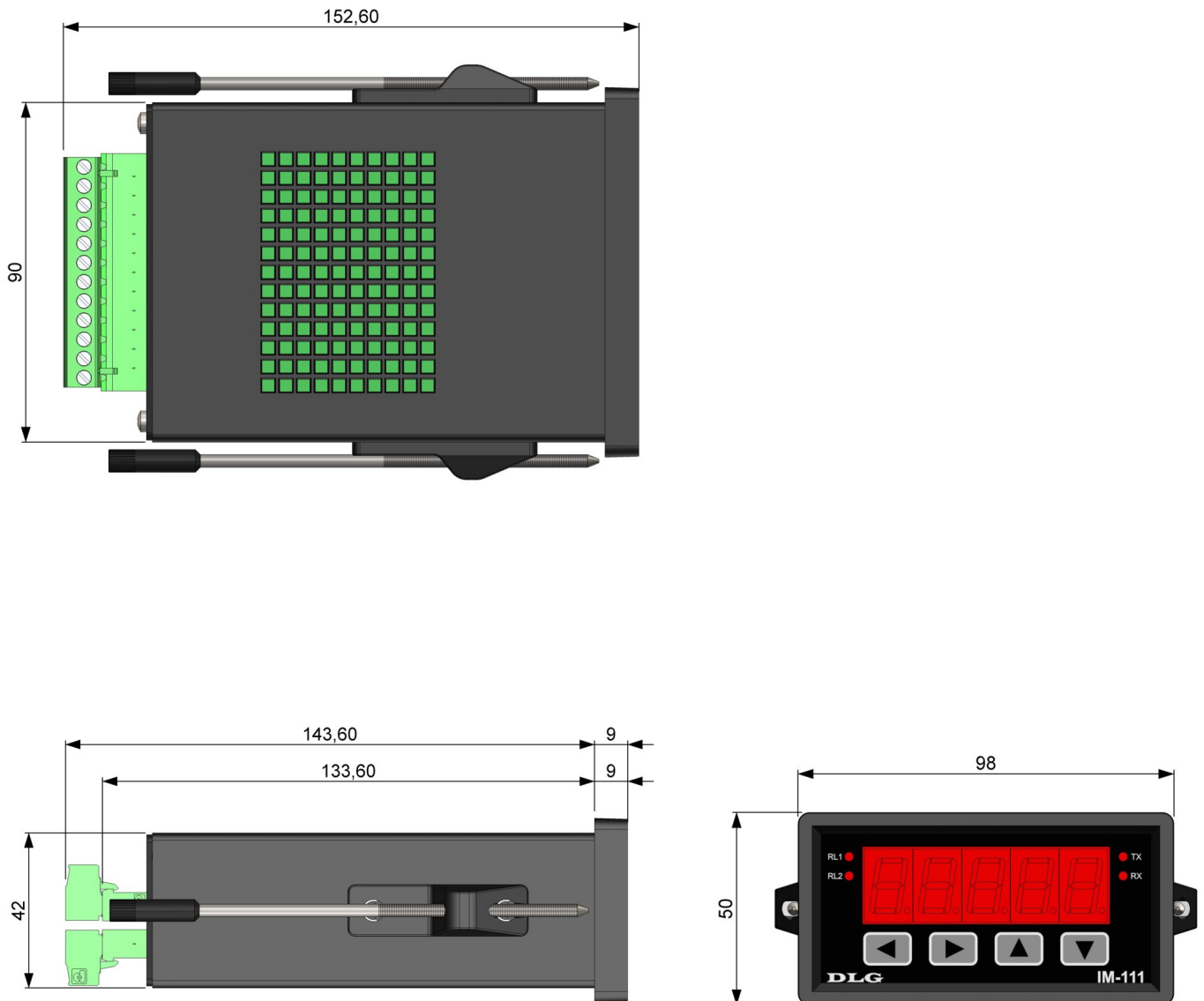

Figure 1 – Dimensioning for assembling (in millimeters)

7 - FUNCTIONALITY

7.1 -FRONTAL DISPLAY



Figure 2 – Frontal display







Frontal	Functions
	Left key, used to navigate through the setup menus. Also used as Return key to exit the previously active menu.
	Right key, used to navigate through the setup menus. Also used as Enter key to enter the selected menu.
	Up key, advances to the next submenu. Also used to increase parameter values.
	Down key, goes back to the previous submenu. Also used to decrease parameter values.
AL1 and AL2	Visual indication of relay 1 and 2 states, respectively.
TX and RX	Indicates Modbus/RTU transmission (TX) and reception (RX).

Table 1 – Frontal keypad functionality

7.2 - KEYPAD FUNCTIONALITY

The configuration parameters are divided into five groups, called menus, which are in turn divided into submenus.



7.2.1 - Menu navigation



To switch between menus, simultaneously press the  and  keys at any time. This combination moves the user to the next menu, regardless of the previously selected submenu. It is important to note that there is no key to return to the previous menu, so the user must press the key combination again until the desired menu is found. *[If the user is unable to access the menus, the frontal keypad may be locked; see section 7.2.4]*

The menu sequence is depicted below.





Menu	Description
Input	Input type (process variable) settings. User can also set measurement unit for temperature indication (Celsius or Fahrenheit degrees), engineering scale minimum and maximum, decimal point for indication, linearization, among others. Submenus contained herein are: <i>In.SET , un.tEP , in.FLo , in.FH1 , Eng.Lo , Eng.H1 , dP.Pos , of.SET , FilT. , LinEA , bu.SEL , bu.Lo , bu.H1</i>
Alarms	Alarm settings: set points, hysteresis, alarm triggering delay. Submenus contained herein are: <i>SP.AL1 , Fu.AL1 , HY.AL1 , AL1.t1 , AL1.t2 , SP.AL2 , Fu.AL2 , HY.AL2 , AL2.t1 , AL2.t2</i>
Output	Retransmission settings: signal type, engineering scale minimum and maximum, safety level and calibration (zero and span). Submenus contained herein are: <i>ou.SET , ou.LoL , ou.HiL , UR.SET , o.2Er0 , o.SPAn</i>
Linearization	Input signal linearization settings. Submenus contained herein are: <i>L.in01 ... L.in20 , L.ou01 ... L.ou20</i>
Modbus communications	Modbus/RTU settings: address, baud rate, parity and response delay. Submenus contained herein are: <i>C.Adr , C.brT , C.PArY , C.dELY</i>

7.2.2 - Submenu navigation





Press the  key to advance to a submenu or the  key to return to the previous submenu.

When a submenu is active, the display will flash between the submenu name and the parameter value. The parameter value can be changed by pressing the  key and then entering the new value. After setting the new value, move the cursor to the first or last digit by pressing the  or  keys. Please note that the display will flash again between the submenu name and the value set for the parameter.

7.2.3 - Leaving configuration mode

Simultaneously press the  and  keys to leave configuration mode. Using the  or  keys choose between *SAVES* (save) or *NO* (do not save). After choosing one of the options, press the  key to confirm the action.

7.2.4 - Locking and unlocking the frontal keypad

The frontal keypad can be locked or unlocked by simultaneously pressing the  and  for 4 seconds while the IM-111 is in normal operation. Using the  or  keys choose between *Y.LoCK* (lock) e *n.LoCK* (unlock) and press the  key to confirm the action.

7.2.5 - Ambient temperature indication

The IM-111 can indicate the ambient temperature in Celsius or Fahrenheit degrees, as configured in submenu Input → *un.tEP*.

The temperature will be indicated in the display while the user holds the  key. After releasing the key, the process variable will be restored to the display.

7.2.6 - Linearization curve input indication

If input signal linearization is enabled, the input signal before linearization can be indicated in the display by holding the  key while in normal operation. After releasing the key, the linearized process variable will be restored to the display.

8 - CONFIGURATION

8.1 - SUBMENU DETAILS

8.1.1 - Input menu

Submenu	Parameter	Description
in.5Et	tc J	Input type selection (process variable). Options are: Thermocouples type J, K, T, R, S, E, N and B Pt100 0-20 mA, 4-20 mA 0-100 mV, 0-5 V, 0-10 V Logic Level No input Frequency
	tc K	
	tc E	
	tc R	
	tc S	
	tc E	
	tc N	
	tc B	
	Pt 100	
	0.207A	
	4.207A	
	1007U	
	5 U	
	10 U	
	Lo9 iC	
oFF		
FrE9		
un.tEP	C	Ambient temperature indication in Celsius (C) or Fahrenheit (F) degrees.
	F	The chosen unit is displayed when the  key is pressed (see item 6.2.5) or when the selected input type is thermocouple or Pt100 (in.5Et submenu).
in.FLo	0 to 30000	Frequency signal lower limit for engineering unit conversion. NOTE: Use only when the input type is frequency.
in.FHi	0 to 30000	Frequency signal higher limit for engineering unit conversion. NOTE: Use only when the input type is frequency.
Eng.Lo	-9999 to 30000	Engineering unit lower limit (display indication).
Eng.Hi	-9999 to 30000	Engineering unit upper limit (display indication).

dP.Pos	00000	Sets the decimal point position for the input value (process variable) and for the engineering scale.
	0000.1	
	000.02	
	00.003	
	0.0004	
oF.SEt	-9999 to 30000	Sets the indication offset. The offset is added to the input variable in engineering units.
F iLt.	10 to 100	Input digital filter. The digital filter calculates the arithmetic mean of the last input values based on this parameter, by using it as the number of samples. For instance, if this parameter is 20, the indicated value will be the arithmetic mean of the last 20 input samples.
L inEA	oFF	Enables (oN) or disables (oFF) the input signal linearization.
	oN	
bu.SEL	oFF	Selects the burn-out behavior. Burn-out is activated when the input value lies outside the engineering unit range. When the input value is lower than the engineering unit minimum limit, the lower burn-out value is indicated. Similarly, when the input value is higher than the engineering unit upper limit, the upper burn-out value is indicated. The user can disable the burn-out (oFF), activate only the lower limit (Lo), activate only the upper limit (Hi) or activate both limits (Hi, Lo).
	Lo	
	Hi	
	Lo Hi	
bu.Lo	-9999 to 30000	Lower burn-out value.
bu.Hi	-9999 to 30000	Upper burn-out value.

8.1.2 - Alarm menu

The IM-111 is equipped with two SPDT relays which can be linked to user configured alarms. In this menu the user can configure the alarm set point, alarm function, alarm hysteresis, alarm operation time and alarm delay. The alarms are indicated by LEDs AL1 and AL2 at the frontal.

Submenu	Parameter	Description
SP.AL1	-9999 to 30000	Alarm 1 set point.
FU.AL1	oFF	Disables alarm 1.
	Lo	Alarm 1 condition is true when the input value (process variable) is lower than the alarm set point.
	Hi	Alarm 1 condition is true when the input value (process variable) is higher than the alarm set point.
	dIF	Alarm 1 condition is true when the input value (process variable) lies outside the range around the alarm 1 set point defined by the alarm 1 hysteresis.
HY.AL1	-9999 to 30000	Alarm 1 hysteresis.
AL1.t1	0 to 1000 s	Alarm 1 operation time (T1). [see item 7.1.2.2]
		The operation time configures for how long the alarm will remain activated after its triggering.
AL1.t2	0 to 1000 s	Alarm 1 delay (T2). [see item 7.1.2.2]
		The delay time is the time between the alarm condition becoming true and the alarm being triggered.
SP.AL2	-9999 to 30000	Alarm 2 set point.
FU.AL2	oFF	Alarm 2 function, same as FU.AL1.
	Lo	
	Hi	
	dIF	
HY.AL2	-9999 to 30000	Alarm 2 hysteresis.
AL2.t1	0 to 1000 s	Alarm 2 operation time (T1). [see item 7.1.2.2]
		The operation time configures for how long the alarm will remain activated after its triggering.
AL2.t2	0 to 1000 s	Alarm 2 delay (T2). [see item 7.1.2.2]
		The delay time is the time between the alarm condition becoming true and the alarm being triggered.

8.1.2.1 - Alarm operation

Figure 3 details the IM-111 alarm operation based on the available alarm settings.

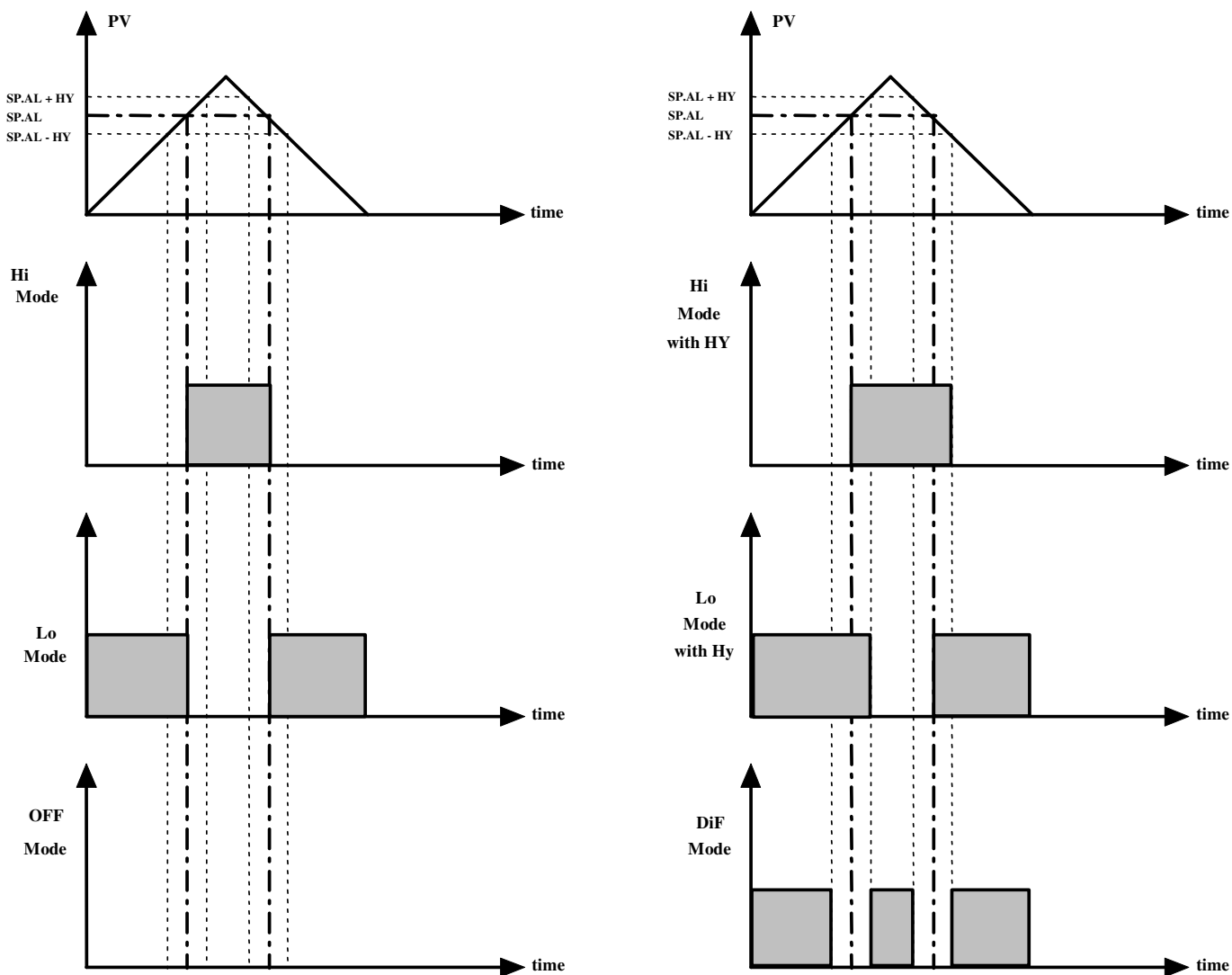

Figure 3 – Alarm operation.

8.1.2.2 - Alarm timing

The IM-111 alarm timing settings provides several advanced functions to be performed. Table 2 details the achievable alarm behaviors.

The LEDs for alarm indication (AL1 and AL2) are lit whenever the respective alarm condition is true, regardless of the output relay state, which may be de-energized based on the timing functions.

Advanced function	T1	T2	Operation
Normal operation	0	0	
Delay	0	1 to 1000 s	
Pulse	1 to 1000 s	0	
Oscillator	1 to 1000 s	1 to 1000 s	

Table 2 – Alarm timing

8.1.3 - Output menu

The IM-111 provides an isolated analog output for input signal (process variable) retransmission in 0-20 mA or 4-20 mA.

Retransmission is always enabled and does not require user intervention to turn it on.

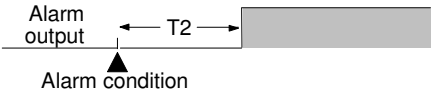
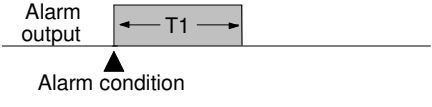
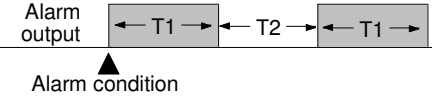
Submenu	Parameter	Description
ou.5Et	E0.207	Sets the retransmission scale. E0.207 : 0-20 mA based on the input engineering range.
	E4.207	E4.207 : 4-20 mA based on the input engineering range.
	L0.207	L0.207 : 0-20 mA based on the range defined by the ou.LoL and ou.HiL parameters.
	L4.207	L4.207 : 4-20 mA based on the range defined by the ou.LoL and ou.HiL parameters.
ou.LoL	-9999 to 30000	Input retransmission lower limit. Only used when the retransmission scale is L0.207 or L4.207.
ou.HiL	-9999 to 30000	Input retransmission upper limit. Only used when the retransmission scale is L0.207 or L4.207.
UR.5E9	-9999 to 30000	Safe retransmission value. The safe retransmission value is retransmitted when the input (process variable) is out of range (burn out).
o.2Ero	-100 to 100	Calibration "zero" setting. Changes the lower calibration value. To restore factory calibration, set this parameter to 0.
o.5PAh	-100 to 100	Calibration span setting. Changes the upper calibration value. To restore factory calibration, set this parameter to 100.

8.1.4 - Linearization menu

The IM-111 provides linearization for the input and/or the retransmitted signal. The linearization is based on line segments defined by up to 20 points.

Submenu	Parameter	Description
L.in01 . . . L.in20	-9999 to 30000	Input signal (process variable) linearization. May be set between engineering unit minimum and maximum (see section 7.1.1, Eng.Lo and Eng.Hi parameters).
L.out01 . . . L.out20	-9999 to 30000	Output signal linearization in engineering units.

When the user selects the L0.207 or L4.207 parameters (Output menu → ou.5Et submenu), it is possible to define a customized linearization cycle. The input signal can be divided in 20 segments, so as to minimize the error between the input signal and the corresponding indication. The L.in01 parameter corresponds to the start point of the first segment, which must match the input signal minimum value. Next, L.in02 is the starting point of the second segment and so forth until the L.in20 parameter, which corresponds to the last segment. Next, L.out01 corresponds to the required indication for the first output point. Then, L.out02 is the required indication for the second point and so forth until L.out20. L.in01 must be defined as Eng.Lo. If all 20 linearization points are not needed, the last used linearization point must be defined as Eng.Hi.

The upper and lower indication limits must be defined before the linearization settings.

8.1.5 - Modbus communications menu

Modbus/RTU communications settings can be adjusted in this menu.

Submenu	Parameter	Description
<i>C.Adr</i>	1 to 255	Modbus slave address.
<i>C.brt</i>	9600	Modbus baud rate, in bps (bits per second).
	19200	
	38400	
	57600	
	115200	
<i>C.PArY</i>	<i>EUEn</i>	Parity settings. Even (<i>EUEn</i>), odd (<i>odd</i>) or no parity (<i>nonE</i>).
	<i>odd</i>	
	<i>nonE</i>	
<i>C.dELY</i>	10 to 200 ms	Delay between the Modbus request and response. Changing this parameter can disrupt communications. Make sure the change is necessary before executing it.

9 - MODBUS TABLE

Address	Offset	Mnemonic	Description	Default	Upper limit	Lower limit	Read/Write Retentive/ Non-retentive
40001	0	EAI1	Indicated variable (display)				R
40002	1	MSA1	Alarm 1 and 2 status				R
40003	2	SR01	Relay 1 and 2 status				R
40004	3	STDIV	General status				R
40005	4	TAMB	Ambient temperature (TC cold junction compensation)		120.0	-40.0	R
40006	5	R101	Analog output value	0	100.0	0	R
40007	6	LDREL	Turn on/off relay 1 and 2	0	12	0	R/W
Modbus communications settings							
40008	7	ID	Slave address	1	255	0	R/W R
40009	8	BR0	Baud rate	1	4	0	R/W R
40010	9	PAR0	Parity	2	2	0	R/W R
40011	10	DR0	Response delay	10	100	0	R/W R
Input settings							
40012	11	TYPIN	Input type	13	16	0	R/W R
40013	12	UNTMP	Temperature unit	0	1	0	R/W R
40014	13	FMNIN	Minimum input frequency	0	30000	0	R/W R
40015	14	FMXIN	Maximum input frequency	30000	30000	0	R/W R
40016	15	ENGLO	Minimum engineering unit	0	30000	-9999	R/W R
40017	16	ENGHI	Maximum engineering unit	30000	30000	-9999	R/W R
40018	17	ENGDP	Decimal point	0	3	0	R/W R
40019	18	OFSIN	Input offset	0	30000	-9999	R/W R
40020	19	FLTIN	Input filter	1	100	0	R/W R
40021	20	LINON	Enable linearization	1	1	0	R/W R
40022	21	BRSEL	Burn-out selection	1	3	0	R/W R
40023	22	BRUNDER	Lower burn-out value	1	30000	-9999	R/W R
40024	23	BRUPPER	Upper burn-out value	1	30000	-9999	R/W R
Alarm 1 configuration							
40025	24	SPAL1	Alarm 1 set point	0	30000	-9999	R/W R
40026	25	TPAL1	Alarm 1 type	0	3	0	R/W R
40027	26	HTAL1	Alarm 1 hysteresis	15	30000	-9999	R/W R
40028	27	T1AL1	Alarm 1 T1	0	100	0	R/W R
40029	28	T2AL1	Alarm 1 T2	0	100	0	R/W R
Alarm 2 configuration							
40030	29	SPAL2	Alarm 2 set point	0	30000	-9999	R/W R
40031	30	TPAL2	Alarm 2 type	0	3	0	R/W R
40032	31	HTAL2	Alarm 2 hysteresis	0	30000	-9999	R/W R
40033	32	T1AL2	Alarm 2 T1	0	100	0	R/W R
40034	33	T2AL2	Alarm 2 T2	0	100	0	R/W R
Input linearization							
40035	34	LIN_IN_01	Input linearization – point 1	0	30000	-9999	R/W R
40036	35	LIN_IN_02	Input linearization – point 2	0	30000	-9999	R/W R
40037	36	LIN_IN_03	Input linearization – point 3	0	30000	-9999	R/W R

40038	37	LIN_IN_04	Input linearization – point 4	0	30000	-9999	R/W R
40039	38	LIN_IN_05	Input linearization – point 5	0	30000	-9999	R/W R
40040	39	LIN_IN_06	Input linearization – point 6	0	30000	-9999	R/W R
40041	40	LIN_IN_07	Input linearization – point 7	0	30000	-9999	R/W R
40042	41	LIN_IN_08	Input linearization – point 8	0	30000	-9999	R/W R
40043	42	LIN_IN_09	Input linearization – point 9	0	30000	-9999	R/W R
40044	43	LIN_IN_10	Input linearization – point 10	0	30000	-9999	R/W R
40045	44	LIN_IN_11	Input linearization – point 11	0	30000	-9999	R/W R
40046	45	LIN_IN_12	Input linearization – point 12	0	30000	-9999	R/W R
40047	46	LIN_IN_13	Input linearization – point 13	0	30000	-9999	R/W R
40048	47	LIN_IN_14	Input linearization – point 14	0	30000	-9999	R/W R
40049	48	LIN_IN_15	Input linearization – point 15	0	30000	-9999	R/W R
40050	49	LIN_IN_16	Input linearization – point 16	0	30000	-9999	R/W R
40051	50	LIN_IN_17	Input linearization – point 17	0	30000	-9999	R/W R
40052	51	LIN_IN_18	Input linearization – point 18	0	30000	-9999	R/W R
40053	52	LIN_IN_19	Input linearization – point 19	0	30000	-9999	R/W R
40054	53	LIN_IN_20	Input linearization – point 20	0	30000	-9999	R/W R
Output linearization							
40055	54	LIN_OUT_01	Output linearization – point 1	0	30000	-9999	R/W R
40056	55	LIN_OUT_02	Output linearization – point 2	0	30000	-9999	R/W R
40057	56	LIN_OUT_03	Output linearization – point 3	0	30000	-9999	R/W R
40058	57	LIN_OUT_04	Output linearization – point 4	0	30000	-9999	R/W R
40059	58	LIN_OUT_05	Output linearization – point 5	0	30000	-9999	R/W R
40060	59	LIN_OUT_06	Output linearization – point 6	0	30000	-9999	R/W R
40061	60	LIN_OUT_07	Output linearization – point 7	0	30000	-9999	R/W R
40062	61	LIN_OUT_08	Output linearization – point 8	0	30000	-9999	R/W R
40063	62	LIN_OUT_09	Output linearization – point 9	0	30000	-9999	R/W R
40064	63	LIN_OUT_10	Output linearization – point 10	0	30000	-9999	R/W R
40065	64	LIN_OUT_11	Output linearization – point 11	0	30000	-9999	R/W R
40066	65	LIN_OUT_12	Output linearization – point 12	0	30000	-9999	R/W R
40067	66	LIN_OUT_13	Output linearization – point 13	0	30000	-9999	R/W R
40068	67	LIN_OUT_14	Output linearization – point 14	0	30000	-9999	R/W R
40069	68	LIN_OUT_15	Output linearization – point 15	0	30000	-9999	R/W R
40070	69	LIN_OUT_16	Output linearization – point 16	0	30000	-9999	R/W R
40071	70	LIN_OUT_17	Output linearization – point 17	0	30000	-9999	R/W R
40072	71	LIN_OUT_18	Output linearization – point 18	0	30000	-9999	R/W R
40073	72	LIN_OUT_19	Output linearization – point 19	0	30000	-9999	R/W R
40074	73	LIN_OUT_20	Output linearization – point 20	0	30000	-9999	R/W R
Analog output							
40075	74	RTTYP	Input retransmission scale	4	4	0	R/W R
40076	75	RTMIN	Lower retransmission limit	0	30000	-9999	R/W R
40077	76	RTMAX	Upper retransmission limit	0	30000	-9999	R/W R
40078	77	BURVAL	Burn-out safe retransmission value	0	30000	-9999	R/W R
40079	78	OUTZRADJ	Calibration “zero” setting	0	5000	-5000	R/W R
40080	79	OUTSPADJ	Calibration span setting	0	15000	5000	R/W R
40081	80	INLINVAL	Linearization input				R
40082	81	LOCKEY	Keypad lock		1	0	R/W R
40083	82	TMRLOOP	Program loop remaining time		100	50	R

9.1 - READ-ONLY BIT MASKS

Bit	Function	Comments
Alarm status – address 40002		
0	Alarm 1 0 = Off 1 = On	
1	Alarm 2 0 = Off 1 = On	
Relay status – address 40003		
0	Relay 1 0 = Off 1 = On	
1	Relay 2 0 = Off 1 = On	
General status – address 40004		
0	Calibration memory failure Not implemented	
1	Lower burn-out 0 = Normal 1 = Failure	
2	Higher burn-out 0 = Normal 1 = Failure	
3	Reserved	
4	Digital input 1 0 = Off 1 = On	
5	Digital input 2 0 = Off 1 = On	

9.2 - READ-WRITE BIT MASKS

Value/bit	Function	Comments
Turn on/off relay 1 and 2 – address 40007		
bit 0	Relay 1 off	Write “1” to turn off the relay. Writing “0” has no effect.
bit 1	Relay 2 off	Write “1” to turn off the relay. Writing “0” has no effect.
bit 2	Relay 1 on	Write “1” to turn on the relay. Writing “0” has no effect.
bit 3	Relay 2 on	Write “1” to turn on the relay. Writing “0” has no effect.
Baud rate – address 40009		
0	9600 bps	
1	19200 bps	
2	38400 bps	
3	57600 bps	
4	115200 bps	
Parity – address 40010		
0	Even parity	
1	Odd parity	
2	No parity	
Input type – address 40012		
0	Thermocouple type J	
1	Thermocouple type K	
2	Thermocouple type T	
3	Thermocouple type R	
4	Thermocouple type S	
5	Thermocouple type E	
6	Thermocouple type N	
7	Thermocouple type B	
8	Pt100	
9	0–20 mA	
10	4–20 mA	
11	0–100 mV	
12	0–5 V	
13	0–10 V	
14	Logic	
15	No input	
16	Frequency	
Temperature unit – address 40013		
0	Celsius degrees	

1	Fahrenheit degrees	
Linearization – address 40021		
0	Disabled	
1	Enabled	
Burn-out selection – address 40022		
0	Burn-out OFF	
1	Burn-out LOW	
2	Burn-out HIGH	
3	Burn-out LOW and HIGH	
Alarm type 1 – address 40026		
0	Alarm 1 OFF	Triggers relay 1
1	Alarm 1 LOW	
2	Alarm 1 HIGH	
3	Alarm 1 DIFFERENTIAL	
Alarm type 2 – address 40031		
0	Alarm 2 OFF	Triggers relay 2
1	Alarm 2 LOW	
2	Alarm 2 HIGH	
3	Alarm 2 DIFFERENTIAL	
Input retransmission scale – address 40075		
0	0 – 20 mA or 0 – 10 V retransmission based on the input engineering range	
1	0 – 20 mA or 0 – 10 V retransmission based on lower and upper limits	
2	4 – 20 mA or 2 – 10 V retransmission based on the input engineering range	
3	4 – 20 mA or 2 – 10 V retransmission based on lower and upper limits	

10 - ELECTRICAL INSTALLATION

10.1 - REAR CONNECTORS

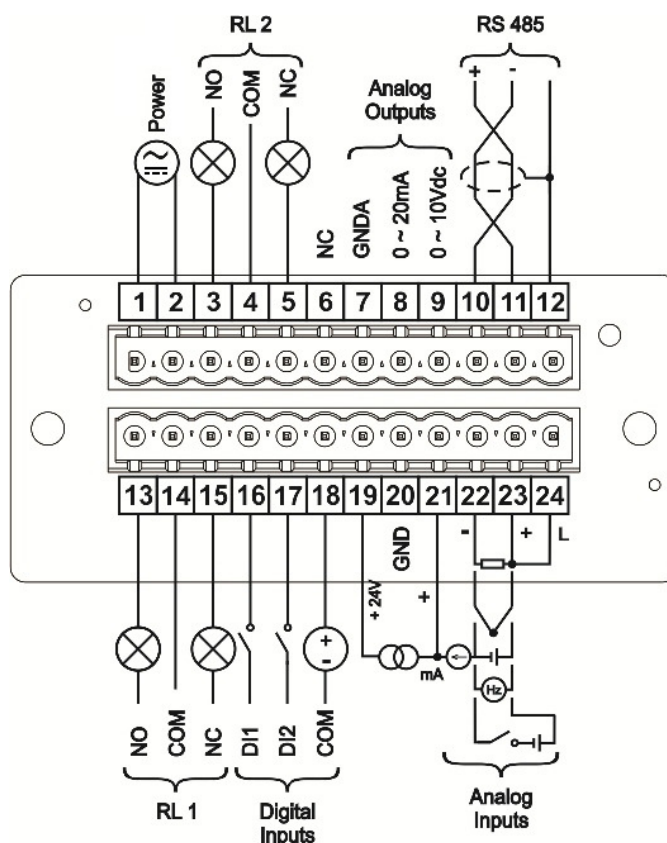

Connectors				
Pin	Function		Pin	Function
1	AC: L1	DC: -	13	Relay 1 (NO connection)
2	AC: L2	DC: +	14	Relay 1 (common)
3	Relay 2 (NO connection)		15	Relay 1 (NC connection)
4	Relay 2 (common)		16	Digital input 1
5	Relay 2 (NC connection)		17	Digital input 2
6	Not used		18	Digital inputs (common)
7	Retransmission (GND)		19	24 Vdc (auxiliary power supply)
8	Retransmission (mA)		20	GND (auxiliary power supply)
9	Retransmission (Vdc)		21	Input (mA)
10	485+		22	Input (GND)
11	485-		23	Input (Vdc and frequency)
12	485 shield		24	Input (RTD)

NOTE: when the voltage output is used, the voltage output must be short-circuited with the current output (pins 8 and 9) and this connection must be used as the positive terminal.

10.2 - INPUT SIGNAL CONNECTION

Current: 0 ~ 20mA or 4 ~ 20mA

Connection for sensors that actively transmit current (different connections for signal and power) up to 20 mA. Positive signal is connected to pin 21 and negative signal to pin 22. **Inverted connections are not supported.**

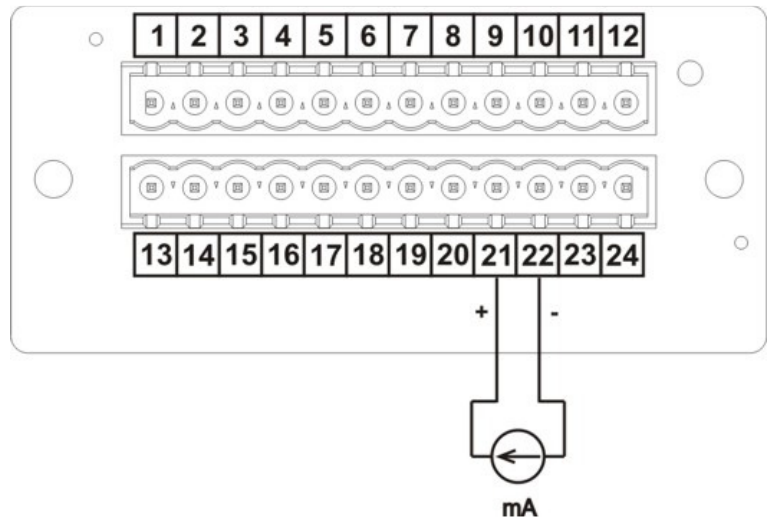

XTR: 0 ~ 20mA or 4 ~ 20mA

Connection for sensors that passively transmit current (same connection for signal and power) up to 20 mA. Positive signal is connected to pin 21 and negative signal to pin 21.

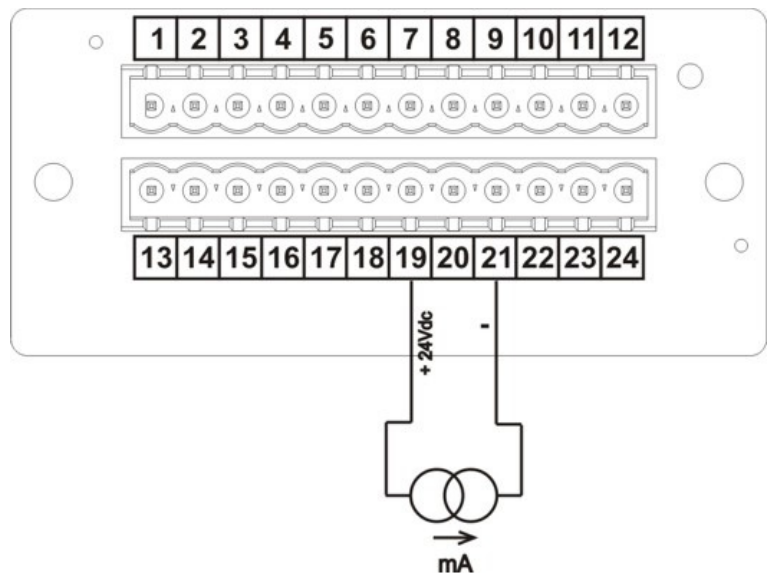

Voltage: 0 ~ 10V, 0 ~ 5V or 0 ~ 100mV

Connection for voltage based sensors, up to 10 V. Positive terminal is connected to pin 23 and negative terminal to pin 22.

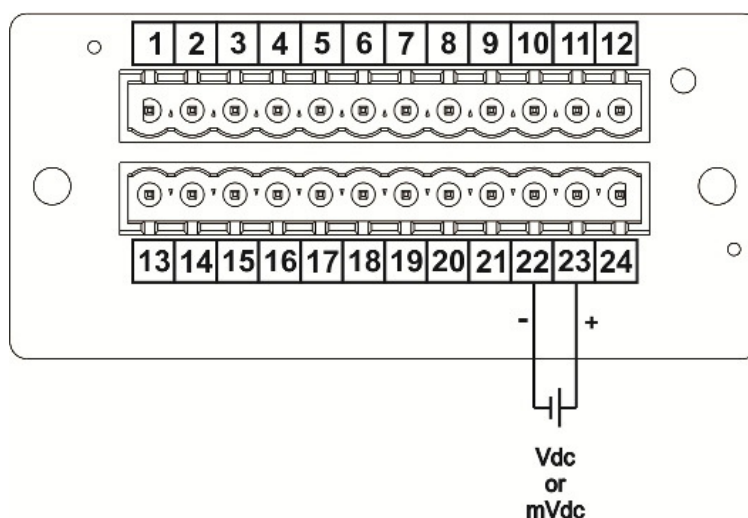

Thermocouple

Connection for J, K, T, R, S, E, N and B thermocouples. Positive terminal is connected to pin 23 and negative terminal to pin 22.

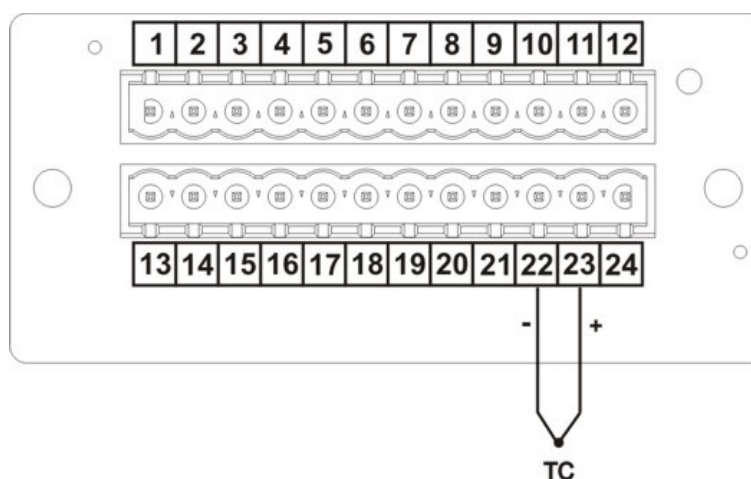

Frequency

Connection for frequency based sensors, with 50 V allowed peak voltages. Positive terminal is connected to pin 23 and negative terminal to pin 22.

NOTE: Apply recommended grounding to avoid noise in the frequency signal.

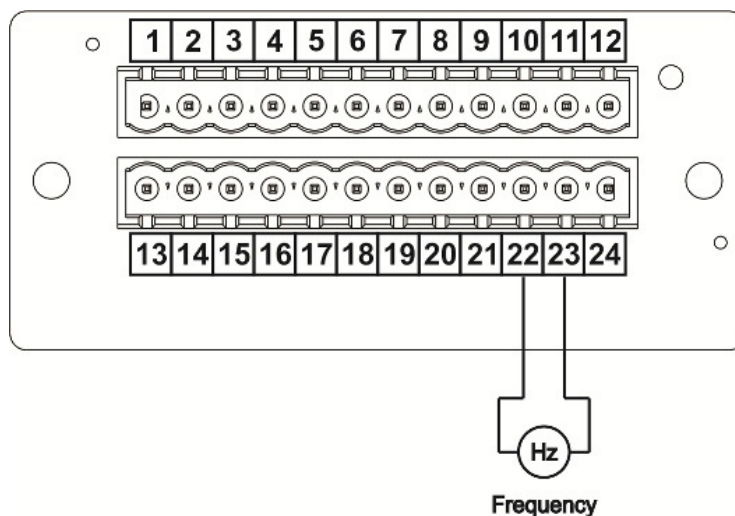

Pt100

Connection for 3-wire Pt100 thermoresistance sensors, with maximum impedance (cables included) of 440Ω. Connect the negative signal (single wire) to pin 22, the positive signal (one of the parallel wires) to pin 23 and the line terminal (the other parallel cable) to pint 24. **This is the only supported connection mode.**

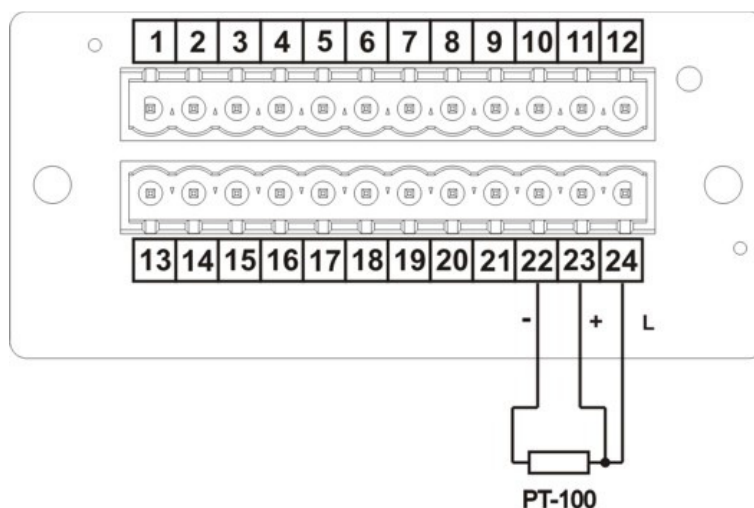

Logic

Connection for dry contact sensors. Maximum supported voltage is **10 V**. Positive terminal is connected to pin 23 and the negative terminal to pin 22. **Inverted polarity is not supported.**

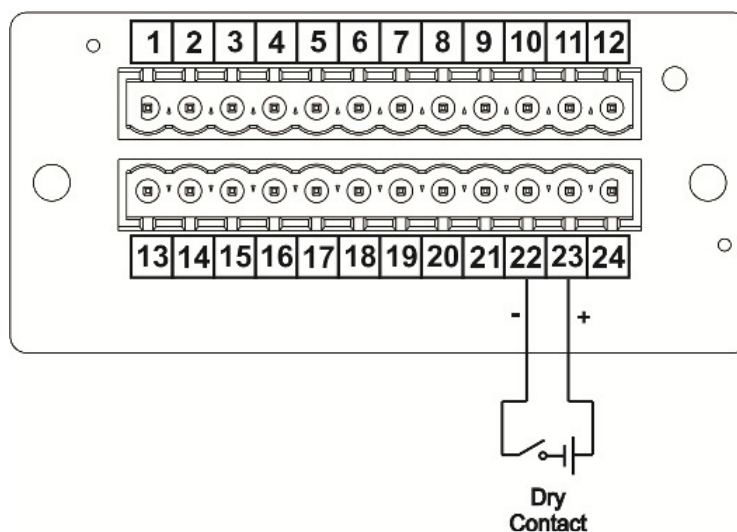

10.3 - OTHER CONNECTIONS

AC power supply

90 to 240 Vac must be connected between pins 1 and 2.

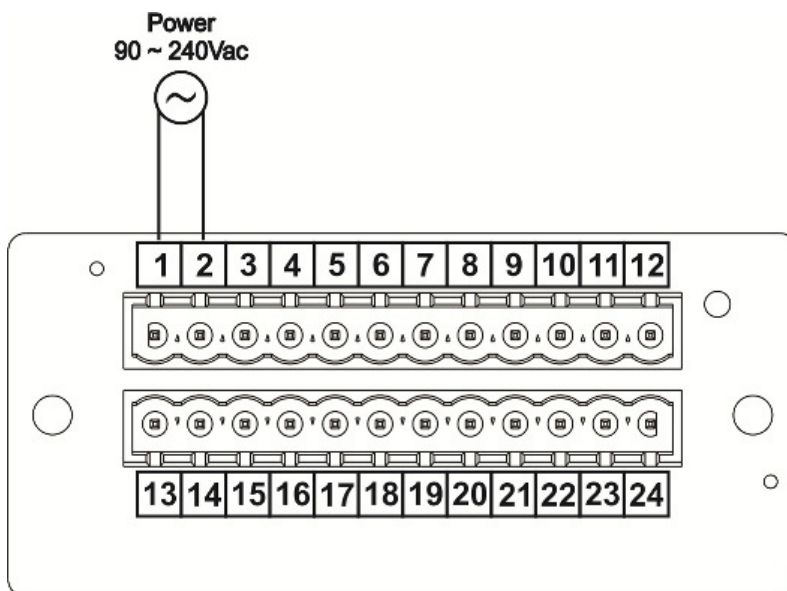

DC power supply

18 to 30 Vdc must be connected between pins 1 (-) and 2 (+).

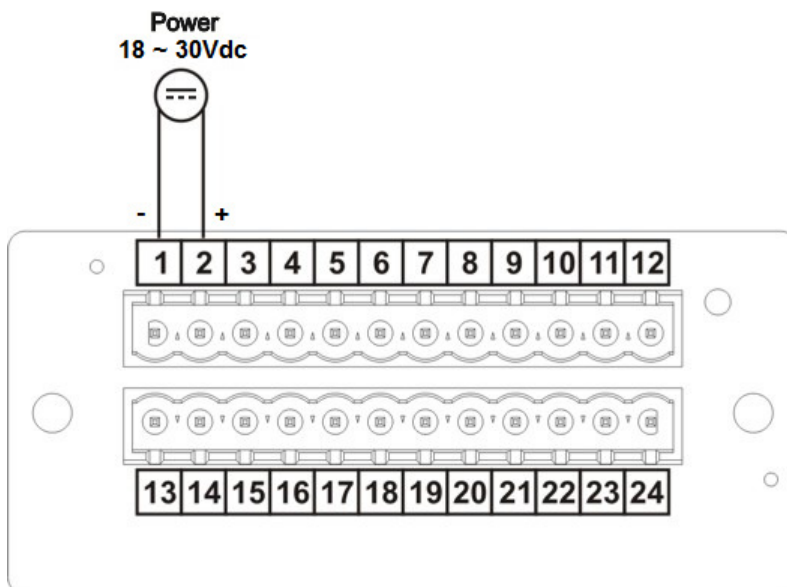

Relay connections

Each relay has a NO (normally open) and a NC (normally closed) contact.

Relay 1 uses pins 3, 4 and 5; relay 2 uses pints 13, 14 and 15. Maximum relay load is 3 A / 220 Vac.

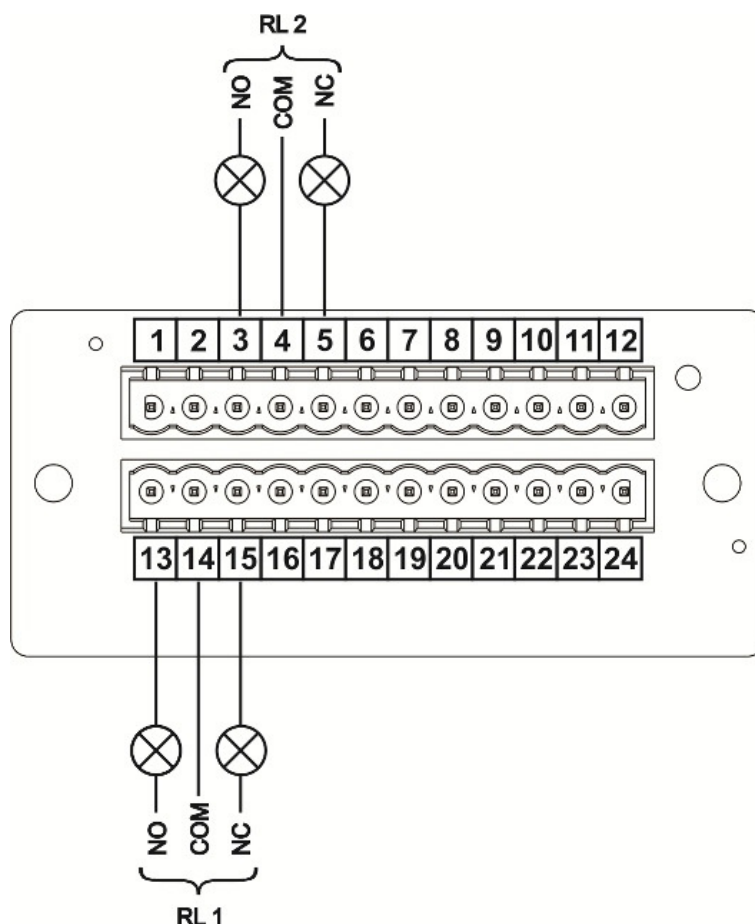

Auxiliary power supply

The IM-111 provides a regulated 24 Vdc auxiliary power supply for loads up to 50 mA.

The power supply connectors are pin 19 (+) and 20 (-).

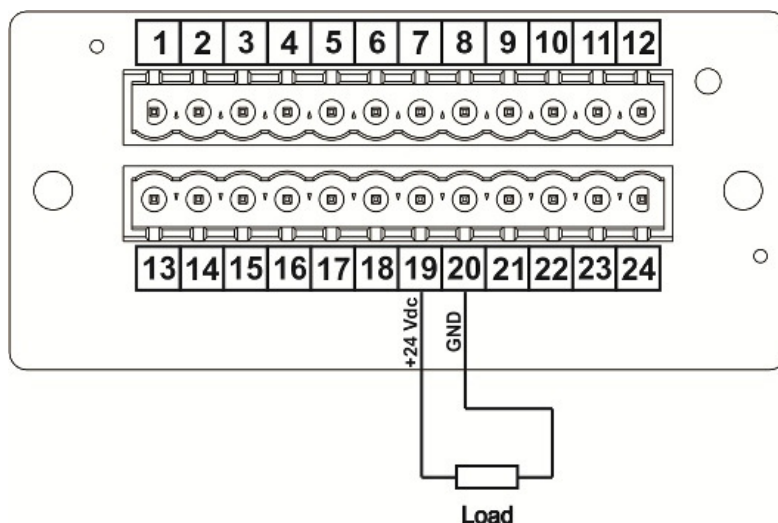

RS-485 (Modbus)

RS-485 port for Modbus communications. Pins used are 10 (+), 11 (-) and 12 (shield).

Twisted pair cables with shielding are recommended, grounded at one end and with maximum length of 1200 meters.

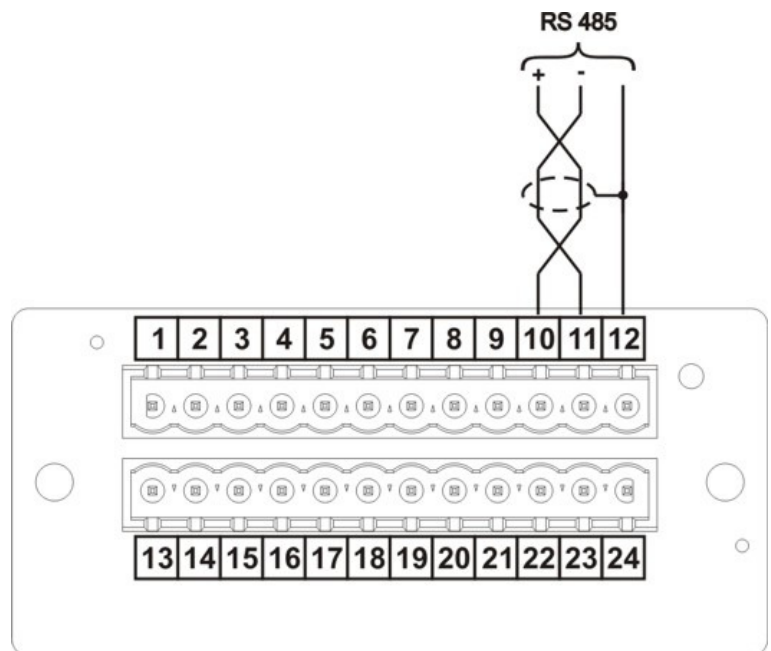

0/4 ~ 20mA retransmission

0/4 ~ 20mA signal retransmission between pins 7 and 8.

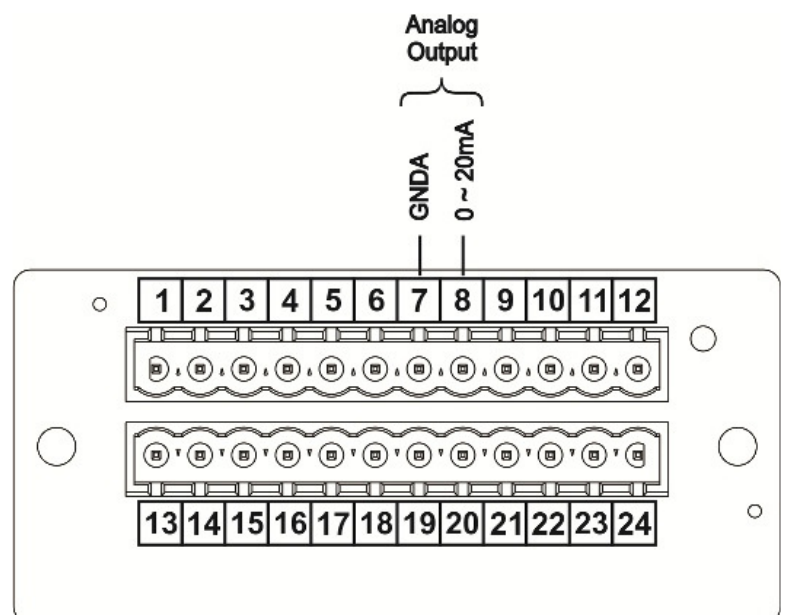

0/2 ~ 10Vdc retransmission

0/2 ~ 10Vdc signal retransmission between pins 8 and 9 (positive) and pin 7 (negative).

Attention: in order to use voltage retransmission, pins 8 and 9 must be short circuited and used as positive terminal.

Note: it is not possible to use voltage and current retransmission simultaneously.

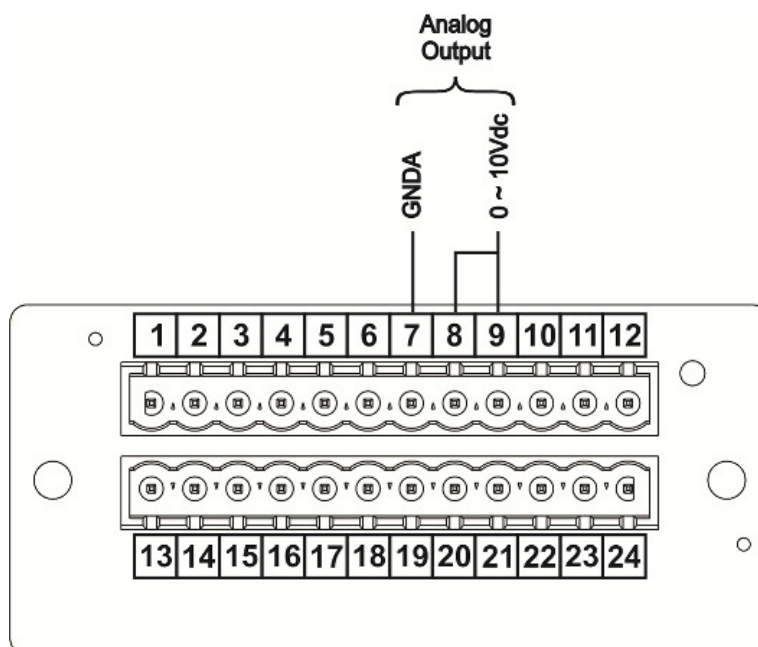

Digital inputs

Isolated, optically coupled inputs. An external power supply (12 ~ 24 Vdc) must be connected to pin 18, and the inputs (input 1 is on pin 16, input 2 on pin 17) are driven by grounding them to the external power supply ground.

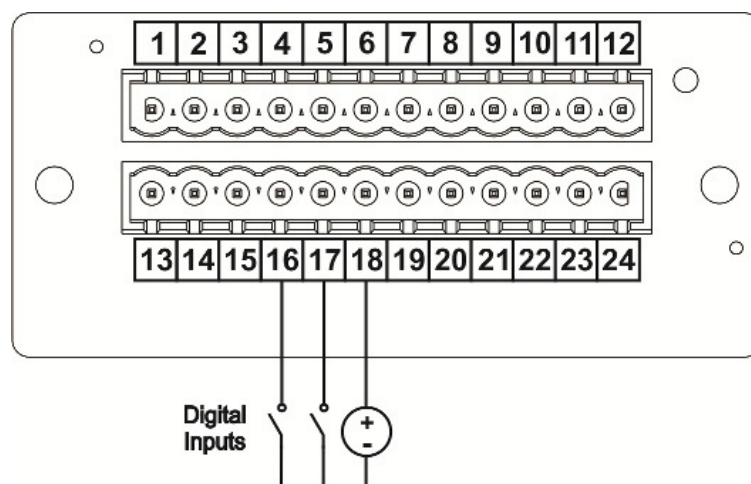



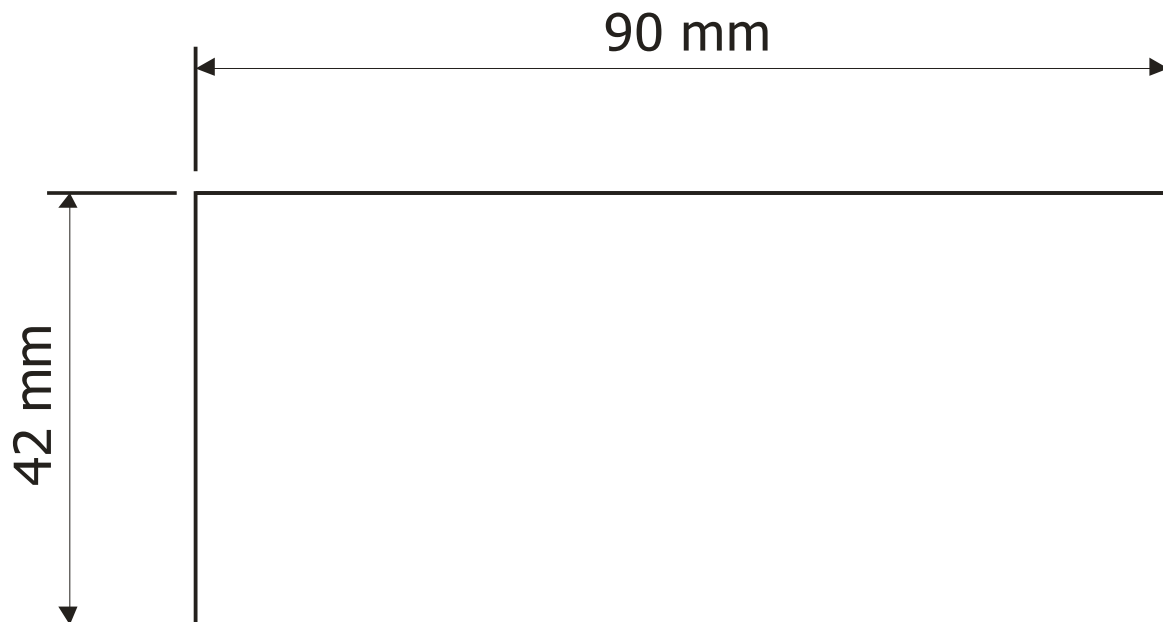

11 - MECHANICAL INSTALLATION

11.1 - REQUIRED PANEL SPACE



12 - RECOMMENDATIONS

It is recommended to use only appropriate tools for the IM-111 installation and maintenance.

<p>It is necessary to use a “terminal” type screwdriver for terminal connection or 1/8 with 3mm maximum diameter, as it is the ideal format and will not damage the connection aperture.</p>	 <p>Inappropriate screwdriver</p>	 <p>Recommended screwdriver</p>
<p>It is recommended to crimp all the wires that will be connected to the IM-111 with a pre-isolated “needle” type or “eyelet” type terminal for cables of 0,5 ~ 1,5mm².</p>	<p>Needle terminal</p> 	<p>Eyelet terminal</p> 

The IM-111 is designed to be frontal panel mounted, free of humidity or dust.

12.1 - RS-485 CABLING

The RS-485 cable should have low capacitance, inductance and resistance per meter. It is recommended specific cabling for long distance, high bandwidth data communications.

The data communications cable must be installed away from noise sources, like motors, drives and high voltage cables.

12.1.1 - Cable length

Cable length must be specified according to required bandwidth and depends on the cable electrical properties (impedance and signal rise time). Maximum distance is 1200 meters with 9600 bps bandwidth.

13 - WARRANTY

The manufacturer assures to equipment owners, identified by the purchase invoice, warranty of 1 (one) year as follows:

1. The warranty period begins with the invoice issuing.
2. Within the warranty period, the labor and parts used for repairing normal use damage are free.
3. For repairs, send the equipment along with the shipping invoices to our factory in Sertãozinho. DLG's address is available at the end of this manual.
4. The owner is responsible for transportation costs and risks.
5. Warranty will be automatically suspended if changes are made to the equipment by personnel not authorized by DLG, defects caused by mechanical shock, exposure to conditions unfit for use of tampering with the product.
6. DLG disclaims any charge relating to unauthorized repairing or replacements due to failures caused by agents external to the equipment, the improper use of them and as a result of unforeseeable circumstances or major forces.
7. DLG ensures full operation of the equipment described herein and all existing operations.

Notes



DLG Automação Industrial Ltda.
Rua José Batista Soares, 53
Distrito Industrial – 14176-119
Sertãozinho – São Paulo – Brasil
Fone: +55 (16) 3513-7400
www.dlg.com.br

MAN-EN-DE-IM111-
01.00_15

UNIVERSAL MODBUS INDICATOR
IM-111

DLG reserves the right to change this manual contents without notice in order to keep it updated with potential product developments.