

# Universal Remote Modbus

## XM-210





# Introduction

Thank you for choosing our Universal Remote Modbus XM-210. To ensure its proper and efficient usage, it's important to read this manual thoroughly to understand how to operate the XM-210, before putting it into operation.

## About this Manual

- 1 - This manual should be delivered to the end user of the XM-210;
- 2 - The contents of this manual are subject to change without notice;
- 3 - All rights reserved. No part of this manual may be reproduced in any form without the written permission from DLG;
- 4 - The specifications contained herein are limited to standard models and do not cover special products made by order;
- 5 - All precautions were taken on preparing this manual, in order to guarantee the quality of its information;

## CAUTION!

The instrument described in this technical user manual is a device suitable for application in a specialized technical area. DLG supplied products are submitted to a strict quality control process. However, industrial control electronic equipment can cause damage to machinery or processes controlled by them in the event of any failure or improper operations and may even endanger human lives. The user is responsible for setting and selecting values of the parameters of the instrument. The manufacturer warns of the risks of incidents with injuries to both people and goods, resulting from the incorrect use of the instrument.

# Contents

<b>INTRODUCTION .....</b>	<b>3</b>
<b>CONTENTS .....</b>	<b>4</b>
<b>PRESENTATION .....</b>	<b>5</b>
<b>HOW TO SPECIFY .....</b>	<b>6</b>
<b>TYPICAL APPLICATIONS .....</b>	<b>7</b>
<b>TECHNICAL SPECIFICATIONS .....</b>	<b>8</b>
Input Characteristics .....	8
General characteristics and precision .....	9
<b>DIMENSIONS .....</b>	<b>10</b>
<b>MECHANICAL INSTALLATION .....</b>	<b>11</b>
<b>ELECTRICAL INSTALLATION .....</b>	<b>12</b>
Power Supply .....	13
Digital Inputs .....	13
Relay outputs and alarms .....	13
PT-100 input .....	15
Thermocouple inputs .....	15
Current inputs .....	16
Voltage inputs .....	16
Logic level inputs .....	17
Frequency inputs .....	17
Auxiliary power supply .....	17
Modbus communication .....	18
<b>OPERATING .....</b>	<b>19</b>
Starting the XM-210 .....	19
Reset .....	20
Indication .....	20
Modbus table .....	21
Modbus register details .....	27
<b>RECOMMENDATIONS .....</b>	<b>30</b>
<b>WARRANTY .....</b>	<b>31</b>

## Presentation

The Universal Remote Modbus XM-210 is designed to promote versatility and robustness in industrial plants.

With its processing core based in the ARM® technology, the XM-210 offers speed and accessibility to field variables through the Modbus RTU protocol over the RS-485 physical interface, thus enabling the acquisition of 16 inputs from several kind of signals such as thermocouples, RTD resistive sensors, current, tension, frequency and logical levels.

The available inputs and product features are described below:



Figure 1

- Thermocouples type J, K, T, R, S, E, N, B (ITS-90) with cold junction compensation
- RTD type PT-100 (two or three wires)
- Current 0-20 mA and 4-20 mA
- Tension 0-75 mV, 0-5 V and 0-10 V
- Logic level maximum amplitude 10 Vdc
- Frequency up to 10KHz with 4 simultaneous channels with 0,3 V to 50 V sensibility
- 2 digital inputs isolated up 30 V for of alarms and status recognition
- 2 alarm levels per channel, configurable (high, low, differential) with hysteresis and delay of 1 to 10 seconds
- 2 relay outputs for alarm status
- 24 Vdc, 150 mA auxiliary power supply
- Fully detachable (plug-in type) connection to the terminal block

The XM-210 is configured by the universal DLG configurator tool DLGTools. The XM-210 features two simultaneous and isolated communications ports, making all data available through Modbus, which makes the XM-210 an excellent tool for feeding field data to controllers and HMI systems.

## How to Specify

XM-210 \_\_\_\_\_

**Power**

AC 90 ~ 260 Vac

DC 18 ~ 30 Vdc

## Typical Applications

The Universal Remote Modbus XM-210 is designed for several types of industrial applications, easing the concentration of distributed field data. The XM-210 applications demonstrate high optimization in remote field data acquisition, which were previously delegated to controllers, increasing the process scalability and decreasing costs.

All the 16 inputs of the XM-210 acquire field data reliably for the supervision and control systems, so the universal remotes can be highly used to collect information from any point of the plant floor.

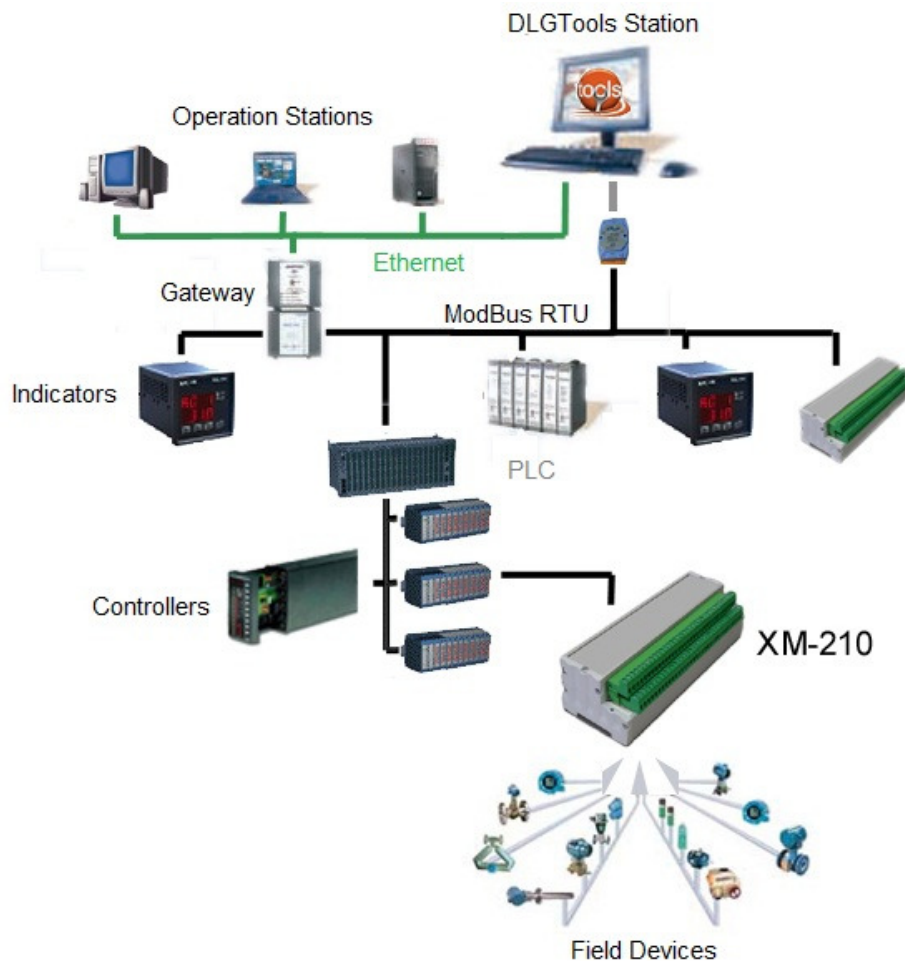

Figure 2 – Modbus network topology with the XM-210

## Technical Specifications

### Input Characteristics

Type	Parameter	Min	Max	Comments	Unit	
<b>Input signal</b>	Current	0	20	Burnout in 3,5	mA	
	Voltage	0	10		Vdc	
	Logic level	0	10			
	Thermocouple		600	1820	B	°C
			-180	1000	E	
			-210	1200	J	
			-260	1370	K	
			-260	1300	N	
			-50	1760	R	
			-50	1800	S	
	-260	400	T			
Cold junction comp.	-10	+60	Operating range			
PT-100	-200	850	Two or three wires Burnout in V, G or I Configurable Burnout Value			
Frequency	0,0004	10	0,3 to 50Vcc sensibility		kHz	
<b>Input impedance</b>	Current	49			Ω	
	Voltage	5			MΩ	
	Thermocouple	5				
	PT-100	5				
	Frequency	150	@10Vp 10KHz		KΩ	
<b>A/D precision (FS)</b>	Current	0-20	± 1		uA	
		4-20	± 1			
	Voltage	0-75	± 0,003		mV	
		0-5	± 0,25			
		0-10	± 0,5			
	Thermocouple	± 0,1			%	
PT-100	Pt	± 0,1				
Cold junction comp.	± 0,5			°C		
<b>Linearization</b>	Thermocouple	0,1			°C	
	PT-100	0,2				
<b>Frequency precision</b>	0,02 @10000Hz			%		



## General characteristics and precision

Type	Comments
<b>Scale</b>	-30000 a +30000 in engineering units
<b>Modbus timeout</b>	Adjustable from 3 ms up to 60 ms (3 ms multiples)
<b>Alarms</b>	Two relay outputs: RL1 e RL2 SPDT max. 3 A / 220 Vac
<b>* Auxiliary power supply</b>	24 Vdc 150 mA
<b>Communication</b>	2 RS-485 ports, isolated and with transient protection filter Configurable even, odd or no parity Baud rates (bps): 1200, 2400, 4800, 9600, 19200, 38400, 57600 and 115200 Modbus RTU protocol
<b>Operating temperature</b>	-10 °C - 60 °C
<b>Thermal stability</b>	±0,005% / °C span @ 25°C.
<b>Relative humidity</b>	Up to 90%
<b>IP protection</b>	IP-50 (DIN EN 60529 VDE 0470)
<b>Input voltage</b>	Universal 90 ~ 265 Vac (XM-210 AC) or 18 ~ 30 Vdc (XM-210 DC)
<b>Current consumption</b>	150 mA
<b>Construction</b>	Aluminum and side panels in PA 6.6-FR (flame resistant polyamide)
<b>Placement</b>	DIN35 rail (DIN EN 60715 TH35)
<b>Electrical connection</b>	Cable up to 2.5mm <sup>2</sup> with "plug-in" type removable connectors
<b>Aprox. weight</b>	0,5 kg
<b>Dimensions</b>	59 x 208 x 75 mm. (height x width x depth).

**\*Feature available only for the XM-210 AC.**

## Dimensions

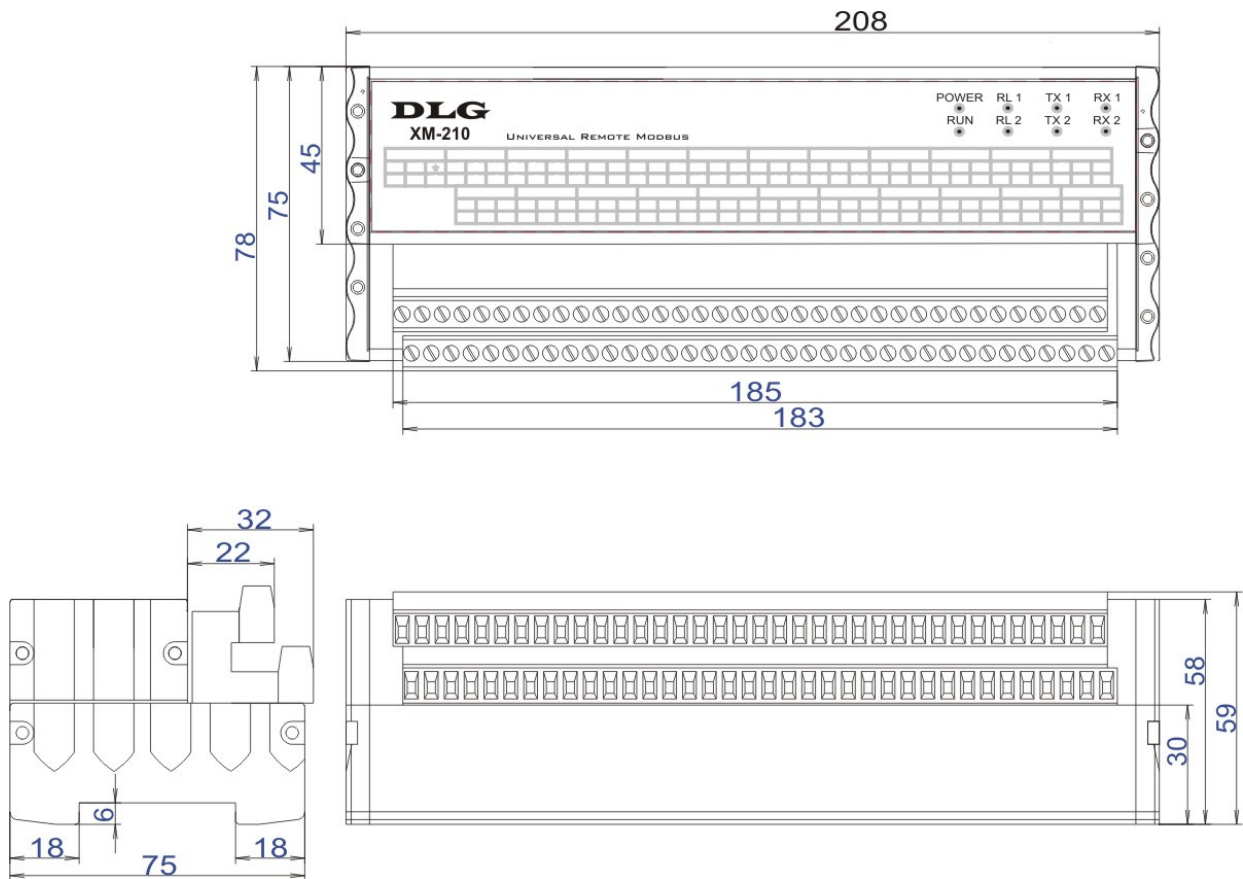

Figure 3 – Dimensioning for assembling (dimension in milimeters)

## Mechanical Installation

To correctly install the Universal Remote Modbus XM-210 an appropriate screwdriver shall be used so the mechanical parts are not damaged. A “terminal” type 1/8” screwdriver is recommended. The following steps details the installation.

1. Place the bottom of the XM-210 in the DIN 35 mm rail as shown in Figure 4.

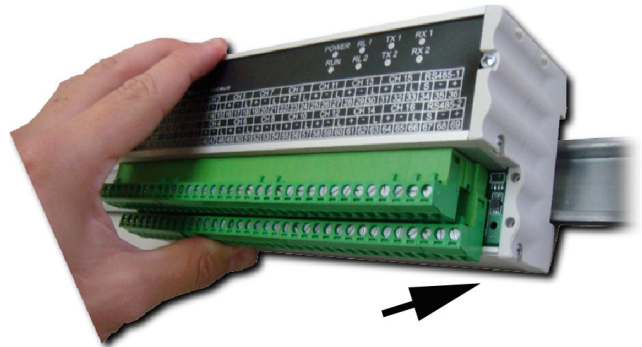

Figure 4

2. Press the top part of the XM-210 until hearing a click. To remove the XM-210, just apply opposite force, i.e., force the XM-210 up and pull it out.

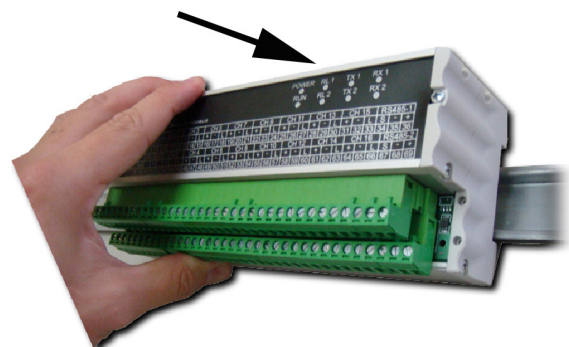

Figure 5

3. The XM-210 is designed to be installed in regular DIN 35 mm trails and after the installation the equipment must remain securely fastened and must not present any slack within the trail. If there is any slack, the trail is possibly not standard.

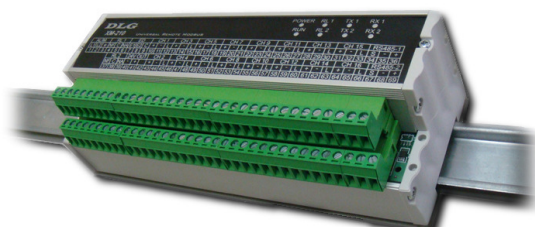
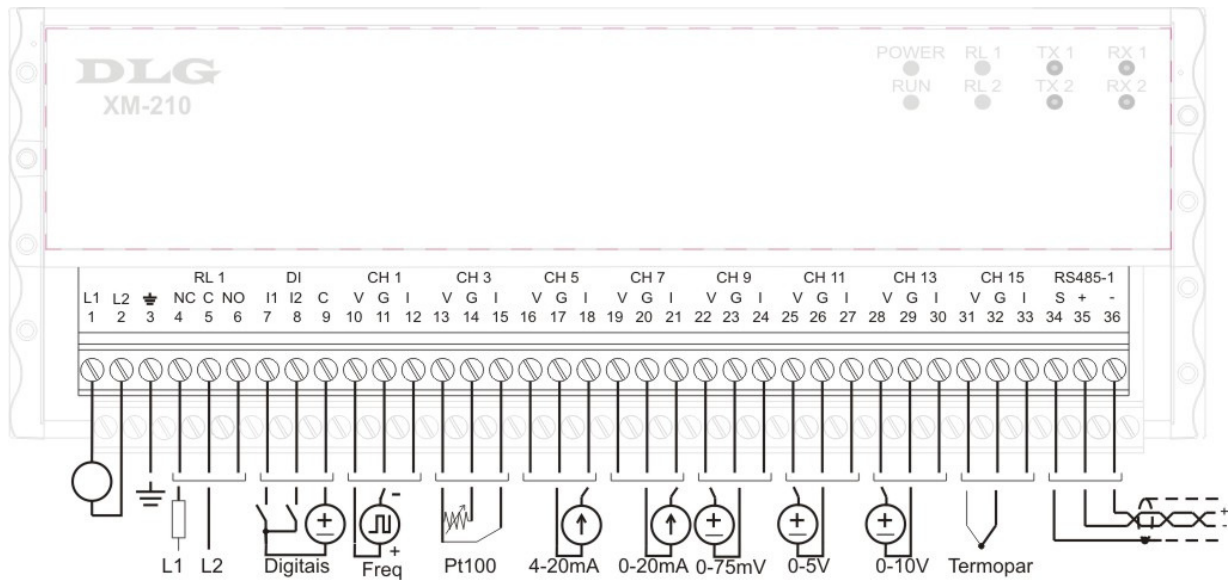
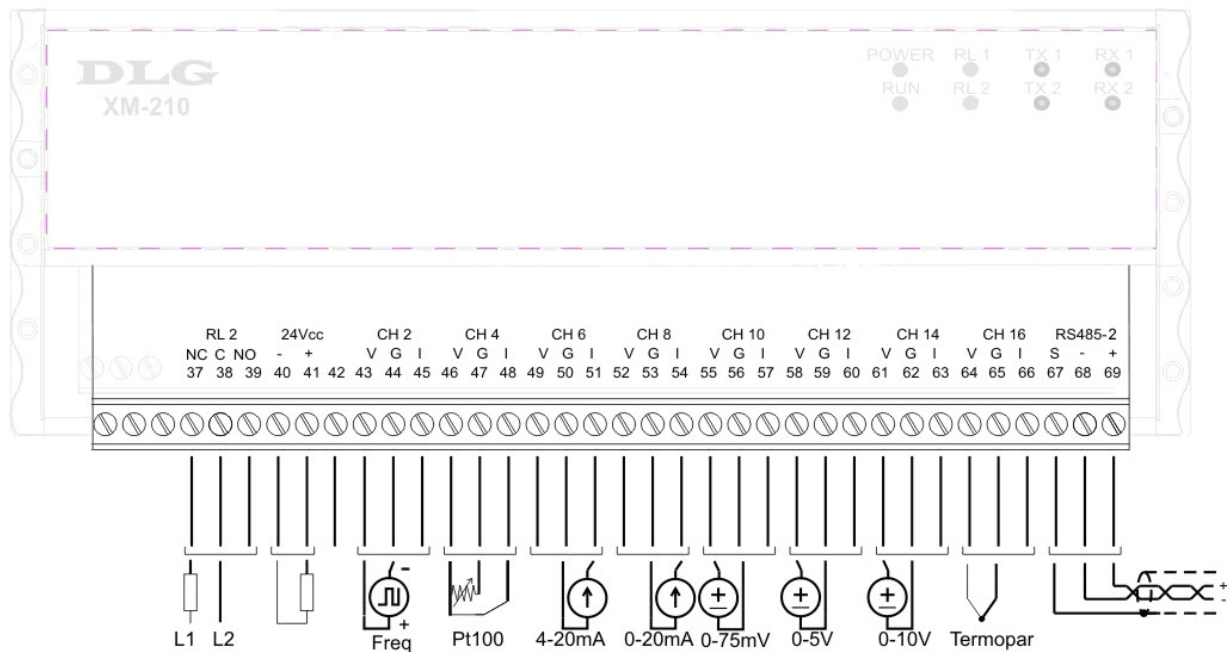

Figure 6

## Electrical Installation



**Figure 7 – Top terminal**

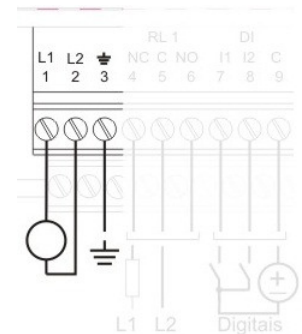

**Figure 8 – Bottom terminal**

**Attention:** All cables must be “crimped” with eyelet type terminals for cables up to 1.5 mm unless otherwise stated. The XM-210 input type selection is done entirely through the DLGTools software and there are no configuration jumpers. It is recommended to use woven shielded cables and the woven grounding should be mostly done around the field instruments at just one point.

## Power Supply

The XM-210 AC must be powered through terminals 1 and 2 with full-range voltage ranging from 90 to 260 Vac. The XM-210 DC must be powered through terminals 1 and 2 with voltage from 18 to 30 Vdc. Terminal 3 is used to ground the "mass" to the panel and it is recommended to use 1.5 mm<sup>2</sup> cables for the phases and 2.5 mm<sup>2</sup> for grounding. The electric scheme is described in the picture.



**Note:** There is no polarity on power terminals 1 and 2 for the XM-210 DC, i.e., the positive can be connected to terminal 1 and negative to terminal 2 or positive to terminal 2 and negative to terminal 1.

## Digital Inputs

The digital inputs are used for alarm status and recognition. The inputs I1 and I2 are photo coupled, with sensibility from 10 to 30 Vdc, common for the two inputs, NPN driven. Digital input I1 is used to reset or recognize RL1 and RL2 alarm conditions and digital input I2 is used like a status flag for general use. The electric scheme is described in the picture where terminals 7 and 8 are the NPN inputs and terminal 9 the positive source common.

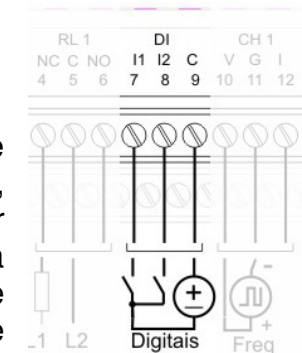

The digital inputs can be read through register 40020.

- Bit 0 – Input 1
- Bit 1 – Input 2
- Bit 3 – Memory error

## Relay outputs and alarms

The relay digital outputs are used to indicate physically alarmed conditions configured for each input. The outputs can only be reseted through the respective digital inputs or through the Modbus address following the procedure described in this topic.

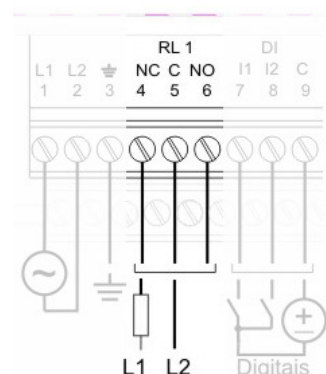

The electric scheme is described in the picture for the SPDT relay type, with the common contact connected to terminals 5 and 38, the NO contacts to terminals 6 and 39 and the NC contacts to terminals 4 and 37.

The relay outputs can be read and written through register 40022.

- Bit 0 – Reset output 1
- Bit 1 – Reset output 2
- Bit 3 – Set output 1
- Bit 4 – Set output 2

The XM-210 has two independent alarms for each input channel totaling 32 alarms.

Each alarm can be configured with up to 4 types of conditions: inoperative, low value, high value and differential.

Inoperative: No alarm.

Low value: The alarm is active as soon as the input value is lower than the set point.

High value: The alarm is active as soon as the input value is higher than the set point.

Differential: The differential mode is defined by the set point and the hysteresis. The set point defines the center reference point and the hysteresis increases the reference range. If the input signal lies inside the reference range that alarm is not active. Otherwise, if the input signal lies outside the reference range, the alarm becomes active. For example, to define a reference ranging from 400 to 600, define the set point as 500 and the hysteresis as 100. When the input signal is lower than 400 or higher than 600 the alarm is active.

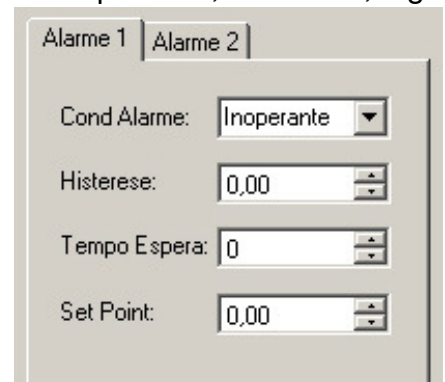

**Figure 9**

When the input signal is lower than 400 or higher than 600 the alarm is active.

The hysteresis is the term relative to the delay between the activation or deactivation of a condition. In the XM-210 the operation mode can change according to the selected alarm condition.

For example:

With low value selected, the activation only happens after the input value is lower than the set point and deactivated when the input value is higher than the set point plus the hysteresis.

With high value selected, the activation only happens after the input value is higher than the set point and deactivated when the input value is lower than the set point less the hysteresis.

The waiting time defines how many seconds the output waits to be activated

### Observations:

For greater security using relays in burn-out conditions, or when there is disruption of the PT-100 cable (see PT-100 input) it is recommended to configure the relay triggering wait time to more than 5 seconds. This condition is important to avoid operational failures, for example, turbine “trips” or any other system that relies on free error states, recalling that burn-out is an error condition of the process.

## PT-100 input

The PT-100 inputs type are linearized according to ITS-90. With a current source circuit and cable compensation the XM-210 eliminates the line charging effect, and with resistive sensors measurement it stands as a precise temperature measurement system. The sensor measurement terminals are positive (V) and negative (G) from channels CH1 up to CH16 and the cable compensation measurement is done in the (I) terminals referenced to the negative (G).

If the PT-100 cables are not connected or are open, a burn-out signal will be represented by an indication of according to the value configured in the BURNOUT RTD register (40246) in the respective channel.

The XM-210 detects the missing sensor and disables the alarm states associated to the open channel.

The PT-100 inputs can be read through registers 40001 up to 40016 if they are configured as PT-100 through the sensor type registers (40030 – 40045), using value 8.

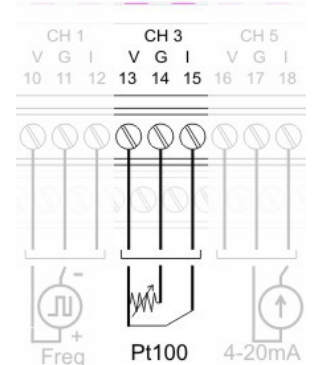

## Thermocouple inputs

The thermocouple inputs are linearized as according to ITS-90. With a cold junction compensation circuit, the XM-210 eliminates the Seebeck effect in the cable connections, standing as a precise system for high temperature or high differentials measurements. The sensor measurement terminals are positive (V) and negative (G) from channels CH1 up to CH16. Terminal (I) is not used in this configuration. Terminal line (I) is not used in this configurations.

The thermocouple inputs can be read through registers 40001 up to 40016 if they are configured as thermocouple through the sensor type registers (40030 – 40045) with the following thermocouple types: 0 to J; 1 to K; 2 to T; 3 to R; 4 to S; 5 to E; 6 to N or 7 to B.

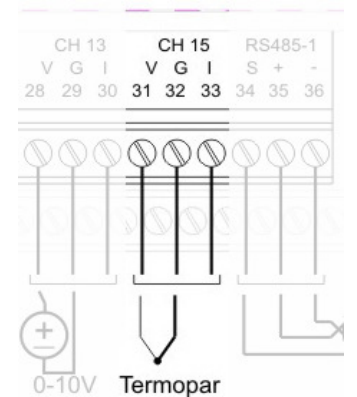

## Current inputs

The XM-210 has two current input configurations: 0-20 mA and 4-20 mA. The scheme for both configurations is described in the picture, where the current loop positive is connected to the line terminals (I) and the negative to terminals (G) from channels CH1 up to CH16. The positive terminals (V) are not used in this configuration.

The current inputs can be read through registers 40001 up to 40016 if they are configured as current inputs through the sensor type registers (40030 – 40045) with the following values: 9 to 0-20 mA or 10 to 4-20 mA

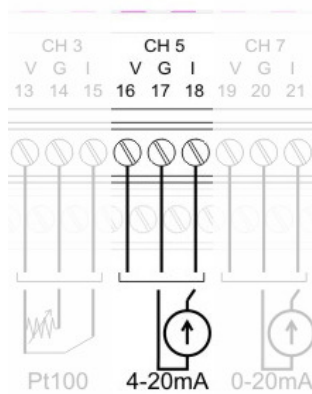

3 Wire Connection

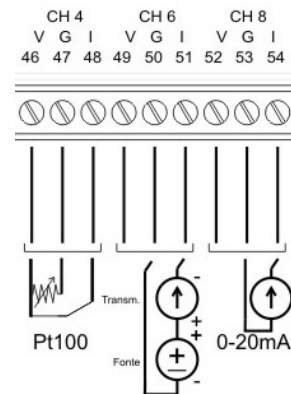

4-20mA

2 Wire Connection

## Voltage inputs

The XM-210 has three voltage input configurations: 0-75 mV, 0-5 V and 0-10 V. The scheme for the configurations is described in the picture, where the positive is connected to the terminals (V) and the negative to terminals (G) from channels CH1 up to CH16. The line terminals (I) are not used in this configuration.

The current inputs can be read through registers 40001 up to 40016 if they are configured as voltage inputs through the sensor type registers (40030 – 40045) with the following values: 11 to 0-20 mV, 12 to 0-5 V or 13 to 0-10 V.

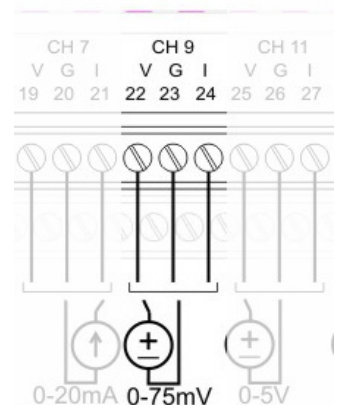

0-20mA 0-75mV 0-5V



## Logic level inputs

The XM-210 has logic level inputs with 0 to 10 Vdc sensibility. The 0 to 3 V range corresponds to logic level 0 while the 5 to 10 V range corresponds to logic level 1. The scheme is described in the picture, where the positive is connected to the terminals (V) and the negative to terminals (G) from channels CH1 up to CH16. The line terminals (I) are not used in this configuration.

The logic level inputs can be read through registers 40001 up to 40016 if they are configured as logic level inputs through the sensor type registers (40030 – 40045) with the value 14.

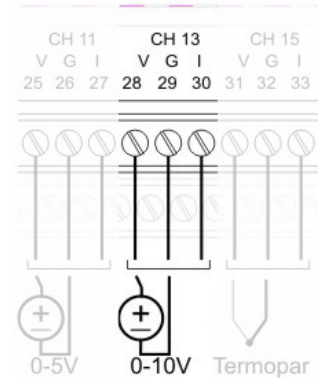

## Frequency inputs

The XM-210 has frequency inputs with 0.3 to 50 Vdc sensibility and 0.3 Hz to 10 KHz reading. The scheme is described in the picture, where the positive is connected to the terminals (V) and the negative to terminals (G) from channels CH1 up to CH4. The line terminals (I) are not used in this configuration.

The frequency inputs can be read through registers 40001 up to 40016 if they are configured as frequency inputs through the sensor type registers (40030 – 40045) with the value 16.

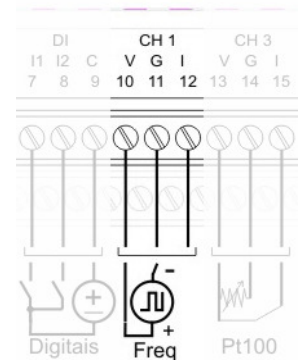

## Auxiliary power supply

The XM-210 auxiliary power supply has high efficiency, low thermal dissipation and supplies 24 Vdc stabilized voltage with maximum 150 mA current. The scheme is described in the picture where the positive is connected to terminal 41 and the negative to terminal 40. Terminal 42 is not used.

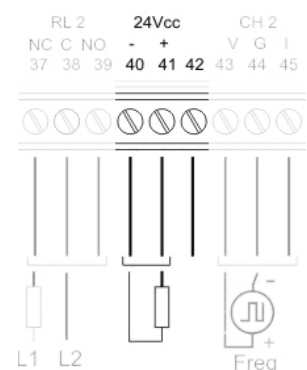

**Note:** Feature available only on the XM-210 AC.

## Modbus communication

The XM-210 has two simultaneous serial communications channels using the Modbus RTU protocol over the RS-485 media. The indication is done by the TX (yellow) and RX (green) leds.

Through isolation and transient protection filters it is possible to establish communication using several rates (1200, 2400, 4800, 9600, 19200, 38400, 57600 and 115200 bps) and parities (even, odd and none).

The picture describes the connection scheme of both channels. For channel 1, the positive is connected to terminal 36 and the negative to terminal 35. For channel 2, the positive is connected to terminal 69 and the negative to terminal 68.

Terminals 34 and 67 must be used for the communications cable woven.

The XM-210 has two registers (40026 e 40029) that adjust the time delay between the master request and the XM-210 response in the Modbus network. These registers allow the configuration of the delay between 2 and 100mS, configurable by DLGTools. This delay is very important when using equipments that need more time between the request and the response or lower communication rates are being used (lower than 19200 bps).

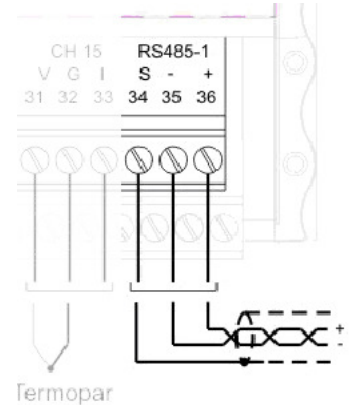

## Operating

### Starting the XM-210

The Universal Remote Modbus XM-210 is designed to ally the advantages in the distribution and collection of the field variables with the Modbus protocol compatibility, being able to make them available along with its settings to controllers and supervision systems.

Through the DLGTools software, the XM-210 can be parameterized over Modbus in a structured hierarchical way. The XM-210 parameterization is structured in: configuration, output alarms, alarm status, supervision, trend and communication. Some items from the XM-210 parameterization follow:

#### **Configuration:**

- Sensor type selection.
- Offset setting for each selected sensor.
- Maximum and minimum engineering unit scales and decimal point.
- Alarm type selection: low, high or differential.
- Alarm hysteresis setting.
- Alarm set point setting.
- Waiting time for alarm activation.

#### **Output alarms:**

- Table for selecting outputs for the input channels.
- All input channels can be configured to activate the outputs.
- Each input channel can create a combination of outputs activation.

#### **Alarm status:**

- Indication of alarm 1 and 2 states for each channel.
- Indication of outputs 1 and 2 states.
- Outputs 1 and 2 reset.

#### **Supervision:**

- Indication of all the values available in the Modbus table.

#### **Trend:**

- Real time or historical graphical trending displaying the 16 inputs simultaneously

#### **Communication:**

- Communications parameterization of baud rate, parity and Modbus address.
- Configurations download and upload.

#### **Led indications:**

- Operation and communications indication through leds in the equipment

## Reset

The reset mode is used to define the communications configuration default state in an emergency condition in which the configuration is unknown. A reset button placed in the right inferior section of the XM-210 is available for this purpose, as displayed in the picture.

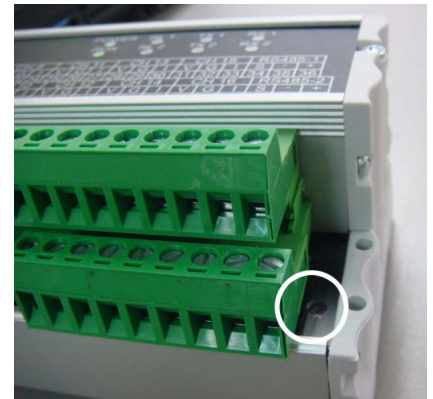

When the button is pressed, the RUN led will blink 6 times per second and the XM-210 temporarily defines the communications settings of the two ports to:

**Address:** 1  
**Baud Rate:** 19200bps  
**Parity:** None

In this moment it is possible to use DLGTools with these parameters to access the equipment. To exit reset mode just save any configuration and the XM-210 automatically redefines the parameters and save them. If the XM-210 is turned off, when turned on again the last configuration saved will be used.

The XM-210 also has a factory init procedure, which is triggered by energizing it with the reset button pressed. Any modification made will be lost and replaced the default parameters.

## Indication

The XM-210 has state indication leds:

- Power: indicates that the XM-210 is energized.
- RUN: Indicates the execution operation mode when the RUN led blinks 2 times per second;
- Indicates the reset operation mode when the led blinks 6 times per second.
- RL1 and RL2: The states of relays 1 and 2.
- TX1 and TX2: The states of communication transmission on channels 1 and 2 (yellow).
- RX1 and RX2: The states of communication reception on channels 1 and 2 (green).



## Modbus table

The table below describes all the Modbus addresses available in the XM-210.

Address	Mnemonic	Description
40001	EAI1	Channel 1 – analog input
40002	EAI2	Channel 2 – analog input
40003	EAI3	Channel 3 – analog input
40004	EAI4	Channel 4 – analog input
40005	EAI5	Channel 5 – analog input
40006	EAI6	Channel 6 – analog input
40007	EAI7	Channel 7 – analog input
40008	EAI8	Channel 8 – analog input
40009	EAI9	Channel 9 – analog input
40010	EAI10	Channel 10 – analog input
40011	EAI11	Channel 11 – analog input
40012	EAI12	Channel 12 – analog input
40013	EAI13	Channel 13 – analog input
40014	EAI14	Channel 14 – analog input
40015	EAI15	Channel 15 – analog input
40016	EAI16	Channel 16 – analog input
40017	MSA1	Alarm status 1, channels 1 - 16
40018	MSA2	Alarm status 2, channels 1 - 16
40019	SR01	Relay 1 and 2 status
40020	STDIV	Digital input 1 and 2 status and memory error
40021	TAMB	Room temperature
40022	R101	Relay deactivation (1 : relay 1, 2 : relay 2) Relay activation (4 : relay 1, 8 : relay 2)
40023	ID	Equipment Modbus address
40024	BR0	Baud rate port 1
40025	PAR0	Parity port 1
40026	DR0	Response delay port 1, 0 to 60 ms
40027	BR1	Baud rate port 2
40028	PAR1	Parity port 2
40029	DR1	Response delay port 2, 0 to 60 ms
40030	TS01	Sensor type channel 1
40031	TS02	Sensor type channel 2
40032	TS03	Sensor type channel 3
40033	TS04	Sensor type channel 4
40034	TS05	Sensor type channel 5
40035	TS06	Sensor type channel 6
40036	TS07	Sensor type channel 7

40037	TS08	Sensor type channel 8
40038	TS09	Sensor type channel 9
40039	TS10	Sensor type channel 10
40040	TS11	Sensor type channel 11
40041	TS12	Sensor type channel 12
40042	TS13	Sensor type channel 13
40043	TS14	Sensor type channel 14
40044	TS15	Sensor type channel 15
40045	TS16	Sensor type channel 16
40046	OF01	Offset channel 1
40047	OF02	Offset channel 2
40048	OF03	Offset channel 3
40049	OF04	Offset channel 4
40050	OF05	Offset channel 5
40051	OF06	Offset channel 6
40052	OF07	Offset channel 7
40053	OF08	Offset channel 8
40054	OF09	Offset channel 9
40055	OF10	Offset channel 10
40056	OF11	Offset channel 11
40057	OF12	Offset channel 12
40058	OF13	Offset channel 13
40059	OF14	Offset channel 14
40060	OF15	Offset channel 15
40061	OF16	Offset channel 16
40062	IH01	Max engineering unit channel 1
40063	IH02	Max engineering unit channel 2
40064	IH03	Max engineering unit channel 3
40065	IH04	Max engineering unit channel 4
40066	IH05	Max engineering unit channel 5
40067	IH06	Max engineering unit channel 6
40068	IH07	Max engineering unit channel 7
40069	IH08	Max engineering unit channel 8
40070	IH09	Max engineering unit channel 9
40071	IH10	Max engineering unit channel 10
40072	IH11	Max engineering unit channel 11
40073	IH12	Max engineering unit channel 12
40074	IH13	Max engineering unit channel 13
40075	IH14	Max engineering unit channel 14
40076	IH15	Max engineering unit channel 15
40077	IH16	Max engineering unit channel 16
40078	IL01	Min engineering unit channel 1
40079	IL02	Min engineering unit channel 2
40080	IL03	Min engineering unit channel 3

40081	IL04	Min engineering unit channel 4
40082	IL05	Min engineering unit channel 5
40083	IL06	Min engineering unit channel 6
40084	IL07	Min engineering unit channel 7
40085	IL08	Min engineering unit channel 8
40086	IL09	Min engineering unit channel 9
40087	IL10	Min engineering unit channel 10
40088	IL11	Min engineering unit channel 11
40089	IL12	Min engineering unit channel 12
40090	IL13	Min engineering unit channel 13
40091	IL14	Min engineering unit channel 14
40092	IL15	Min engineering unit channel 15
40093	IL16	Min engineering unit channel 16
40094	PD01	Decimal point channel 1
40095	PD02	Decimal point channel 2
40096	PD03	Decimal point channel 3
40097	PD04	Decimal point channel 4
40098	PD05	Decimal point channel 5
40099	PD06	Decimal point channel 6
40100	PD07	Decimal point channel 7
40101	PD08	Decimal point channel 8
40102	PD09	Decimal point channel 9
40103	PD10	Decimal point channel 10
40104	PD11	Decimal point channel 11
40105	PD12	Decimal point channel 12
40106	PD13	Decimal point channel 13
40107	PD14	Decimal point channel 14
40108	PD15	Decimal point channel 15
40109	PD16	Decimal point channel 16
40110	H101	Alarm 1 hysteresis value channel 1
40111	H102	Alarm 1 hysteresis value channel 2
40112	H103	Alarm 1 hysteresis value channel 3
40113	H104	Alarm 1 hysteresis value channel 4
40114	H105	Alarm 1 hysteresis value channel 5
40115	H106	Alarm 1 hysteresis value channel 6
40116	H107	Alarm 1 hysteresis value channel 7
40117	H108	Alarm 1 hysteresis value channel 8
40118	H109	Alarm 1 hysteresis value channel 9
40119	H110	Alarm 1 hysteresis value channel 10
40120	H111	Alarm 1 hysteresis value channel 11
40121	H112	Alarm 1 hysteresis value channel 12
40122	H113	Alarm 1 hysteresis value channel 13
40123	H114	Alarm 1 hysteresis value channel 14
40124	H115	Alarm 1 hysteresis value channel 15

40125	H116	Alarm 1 hysteresis value channel 16
40126	H201	Alarm 2 hysteresis value channel 1
40127	H202	Alarm 2 hysteresis value channel 2
40128	H203	Alarm 2 hysteresis value channel 3
40129	H204	Alarm 2 hysteresis value channel 4
40130	H205	Alarm 2 hysteresis value channel 5
40131	H206	Alarm 2 hysteresis value channel 6
40132	H207	Alarm 2 hysteresis value channel 7
40133	H208	Alarm 2 hysteresis value channel 8
40134	H209	Alarm 2 hysteresis value channel 9
40135	H210	Alarm 2 hysteresis value channel 10
40136	H211	Alarm 2 hysteresis value channel 11
40137	H212	Alarm 2 hysteresis value channel 12
40138	H213	Alarm 2 hysteresis value channel 13
40139	H214	Alarm 2 hysteresis value channel 14
40140	H215	Alarm 2 hysteresis value channel 15
40141	H216	Alarm 2 hysteresis value channel 16
40142	C101	Alarm 1 conditions channel 1
40143	C102	Alarm 1 conditions channel 2
40144	C103	Alarm 1 conditions channel 3
40145	C104	Alarm 1 conditions channel 4
40146	C105	Alarm 1 conditions channel 5
40147	C106	Alarm 1 conditions channel 6
40148	C107	Alarm 1 conditions channel 7
40149	C108	Alarm 1 conditions channel 8
40150	C109	Alarm 1 conditions channel 9
40151	C110	Alarm 1 conditions channel 10
40152	C111	Alarm 1 conditions channel 11
40153	C112	Alarm 1 conditions channel 12
40154	C113	Alarm 1 conditions channel 13
40155	C114	Alarm 1 conditions channel 14
40156	C115	Alarm 1 conditions channel 15
40157	C116	Alarm 1 conditions channel 16
40158	C201	Alarm 2 conditions channel 1
40159	C202	Alarm 2 conditions channel 2
40160	C203	Alarm 2 conditions channel 3
40161	C204	Alarm 2 conditions channel 4
40162	C205	Alarm 2 conditions channel 5
40163	C206	Alarm 2 conditions channel 6
40164	C207	Alarm 2 conditions channel 7
40165	C208	Alarm 2 conditions channel 8
40166	C209	Alarm 2 conditions channel 9
40167	C210	Alarm 2 conditions channel 10
40168	C211	Alarm 2 conditions channel 11



40169	C212	Alarm 2 conditions channel 12
40170	C213	Alarm 2 conditions channel 13
40171	C214	Alarm 2 conditions channel 14
40172	C215	Alarm 2 conditions channel 15
40173	C216	Alarm 2 conditions channel 16
40174	T101	Alarm 1 wait time channel 1
40175	T102	Alarm 1 wait time channel 2
40176	T103	Alarm 1 wait time channel 3
40177	T104	Alarm 1 wait time channel 4
40178	T105	Alarm 1 wait time channel 5
40179	T106	Alarm 1 wait time channel 6
40180	T107	Alarm 1 wait time channel 7
40181	T108	Alarm 1 wait time channel 8
40182	T109	Alarm 1 wait time channel 9
40183	T110	Alarm 1 wait time channel 10
40184	T111	Alarm 1 wait time channel 11
40185	T112	Alarm 1 wait time channel 12
40186	T113	Alarm 1 wait time channel 13
40187	T114	Alarm 1 wait time channel 14
40188	T115	Alarm 1 wait time channel 15
40189	T116	Alarm 1 wait time channel 16
40190	T201	Alarm 2 wait time channel 1
40191	T202	Alarm 2 wait time channel 2
40192	T203	Alarm 2 wait time channel 3
40193	T204	Alarm 2 wait time channel 4
40194	T205	Alarm 2 wait time channel 5
40195	T206	Alarm 2 wait time channel 6
40196	T207	Alarm 2 wait time channel 7
40197	T208	Alarm 2 wait time channel 8
40198	T209	Alarm 2 wait time channel 9
40199	T210	Alarm 2 wait time channel 10
40200	T211	Alarm 2 wait time channel 11
40201	T212	Alarm 2 wait time channel 12
40202	T213	Alarm 2 wait time channel 13
40203	T214	Alarm 2 wait time channel 14
40204	T215	Alarm 2 wait time channel 15
40205	T216	Alarm 2 wait time channel 16
40206	S101	Alarm 1 set point channel 1
40207	S102	Alarm 1 set point channel 2
40208	S103	Alarm 1 set point channel 3
40209	S104	Alarm 1 set point channel 4
40210	S105	Alarm 1 set point channel 5
40211	S106	Alarm 1 set point channel 6
40212	S107	Alarm 1 set point channel 7

40213	S108	Alarm 1 set point channel 8
40214	S109	Alarm 1 set point channel 9
40215	S110	Alarm 1 set point channel 10
40216	S111	Alarm 1 set point channel 11
40217	S112	Alarm 1 set point channel 12
40218	S113	Alarm 1 set point channel 13
40219	S114	Alarm 1 set point channel 14
40220	S115	Alarm 1 set point channel 15
40221	S116	Alarm 1 set point channel 16
40222	S201	Alarm 2 set point channel 1
40223	S202	Alarm 2 set point channel 2
40224	S203	Alarm 2 set point channel 3
40225	S204	Alarm 2 set point channel 4
40226	S205	Alarm 2 set point channel 5
40227	S206	Alarm 2 set point channel 6
40228	S207	Alarm 2 set point channel 7
40229	S208	Alarm 2 set point channel 8
40230	S209	Alarm 2 set point channel 9
40231	S210	Alarm 2 set point channel 10
40232	S211	Alarm 2 set point channel 11
40233	S212	Alarm 2 set point channel 12
40234	S213	Alarm 2 set point channel 13
40235	S214	Alarm 2 set point channel 14
40236	S215	Alarm 2 set point channel 15
40237	S216	Alarm 2 set point channel 16
40238	MA11	Alarm 1 relay 1 mask
40239	MA12	Alarm 1 relay 2 mask
40240	MA21	Alarm 2 relay 1 mask
40241	MA22	Alarm 2 relay 2 mask
40242	FREQ1	Maximum frequency for eng. unit channel 1
40243	FREQ2	Maximum frequency for eng. unit channel 2
40244	FREQ3	Maximum frequency for eng. unit channel 3
40245	FREQ4	Maximum frequency for eng. unit channel 4
40246	BURNOUT RTD	Burn-out value for PT100 input

## Modbus register details

The table below details the registers.

Status – 40020	
Bit	Function
0	Digital input 1
1	Digital input 2
2	Error reading calibration memory (0: ok, 1 = error)

Baud rate – 40024 ~ 40027		
Value	Index	Rate
0	0000 0000	1200
1	0000 0001	2400
2	0000 0010	4800
3	0000 0011	9600
4	0000 0100	19200
5	0000 0101	38400
6	0000 0110	57600
7	0000 0111	115200

Parity – 40025 ~ 40028		
Value	Index	Parity
0	0000 0000	Even
1	0000 0001	Odd
2	0000 0010	None

Response delay – 40026 ~ 40029 (V1.1.0)		
Max. value	Min. value	Steps
100	0	1 mS
Minimum delays for each baud rate baud rate		
1200: 6		19200:2
2400: 4		38400:2
4800: 3		57600:2
9600: 2		115200: 2

Alarm conditions – 40142 ~ 40158	
Index	Alarm Condition
0	Low
1	High
2	Differential
3	Inoperative





Alarm Read Status – 40017 (AL1) ~ 40018 (AL2)			
Tipo	Valor	Registro	
		MSB	LSB
All alarms deactivated	0	0000 0000	0000 0000
Alarm channel 1 activated	1	0000 0000	0000 0001
Alarm channel 2 activated	2	0000 0000	0000 0010
Alarm channel 3 activated	4	0000 0000	0000 0100
Alarm channel 4 activated	8	0000 0000	0000 1000
Alarm channel 5 activated	16	0000 0000	0001 0000
Alarm channel 6 activated	32	0000 0000	0010 0000
Alarm channel 7 activated	64	0000 0000	0100 0000
Alarm channel 8 activated	128	0000 0000	1000 0000
Alarm channel 9 activated	256	0000 0001	0000 0000
Alarm channel 10 activated	512	0000 0010	0000 0000
Alarm channel 11 activated	1024	0000 0100	0000 0000
Alarm channel 12 activated	2048	0000 1000	0000 0000
Alarm channel 13 activated	4096	0001 0000	0000 0000
Alarm channel 14 activated	8192	0010 0000	0000 0000
Alarm channel 15 activated	16384	0100 0000	0000 0000
Alarm channel 16 activated	32768	1000 0000	0000 0000

Relay reset – 40022		
Value	Index	Action
1	0000 0001	Deactivate relay 1
2	0000 0010	Deactivate relay 2
3	0000 0100	Activate relay 1
4	0000 1000	Activate relay 2

Sensor type – 40030 ~ 40045			
Type	Value	Register	
		MSB	LSB
Thermocouple J	0	0000 0000	0000 0000
Thermocouple K	1	0000 0000	0000 0001
Thermocouple	2	0000 0000	0000 0010
Thermocouple	3	0000 0000	0000 0011
Thermocouple	4	0000 0000	0000 0100
Thermocouple	5	0000 0000	0000 0101
Thermocouple	6	0000 0000	0000 0110
Thermocouple B	7	0000 0000	0000 0111
PT100	8	0000 0000	0000 1001
0-20 mA	9	0000 0000	0000 1010
4-20 mA	10	0000 0000	0000 1011
0-75 V	11	0000 0000	0000 1000
0-5 V	12	0000 0000	0000 1100
0-10 V	13	0000 0000	0000 1101
Logic	14	0000 0000	0000 1110
No input	15	0000 0000	0000 1111
Frequency	16	0000 0000	0001 0000

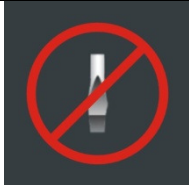
## Recommendations

It's recommended to use only appropriate tools for the XM-210 installation and maintenance.

<p>It is necessary to use a “terminal” type screwdriver for terminal connection or 1/8 with 3mm maximum diameter, as it is the ideal format and will not damage the connection aperture.</p>	 <p><b>Inappropriate screwdriver</b></p>	 <p><b>Recommended screwdriver</b></p>
<p>It is recommended to crimp all the wires that will be connected to the XM-210 with a pre-isolated “needle” type or “eyelet” type terminal for cables of 0.5 - 1.5mm<sup>2</sup>.</p>	<p>Needle terminal</p> 	<p>Eyelet terminal</p> 

It's important to note that when communication errors between the XM-210 and the Modbus master happens they can be easily resolved increasing the time delay in the XM-210.

The delay is very important when equipments that need more time between the request and the response are used or when low communications rate are used (lower than 19200 bps).

## **Warranty**

The manufacturer assures to the equipment owners, identified by the purchase invoice, warranty of 1 (one) year as follows:

- 1 - The warranty period begins on the data of the invoice issue;
- 2 - Within the warranty period, the labor and parts used for repairing damage occurred in normal use are free;
- 3 - For repairs, send the equipment along with the shipping invoices to our factory in Sertãozinho, São Paulo state, Brazil. DLG's address is available at the end of this manual;
- 4 - The owner is responsible for transportation costs and risks;
- 5 - Warranty will be automatically suspended if changes are made to the equipment by personnel not authorized by DLG, defects caused by mechanical shock, exposure to conditions unfit for use or tampering with the product;
- 6 - DLG disclaims any charge relating to unauthorized repairs or replacements due to failures caused by agents external to the equipment, the improper use of them and as a result of unforeseeable circumstances or major forces;
- 7 - DLG ensures full operation of the equipment described herein and all existing operations.



<p><b>DLG</b> Automação Industrial Ltda. Rua José Batista Soares, 53 Distrito Industrial – 14176-119 Sertãozinho – São Paulo – Brasil Fone: +55 (16) 3513-7400 <a href="http://www.dlg.com.br">www.dlg.com.br</a></p>	<p>MAN-EN-DE-XM210- 01.00_15</p>	<p>Universal Remote Modbus XM-210</p>
<p>DLG reserves the right to change this manual contents without notice in order to keep updating it with potential product developments.</p>		